

Toilet Partition Design

For Quotes on Complete Partitions

FOR A QUICK RESPONSE ON PARTITION QUOTES PLEASE:

- **Visit** our website for blank templates in the [design center](#) link in the toilet partition home page.
- **Fax** us the Overhead Drawing to 800-642-2406 OR **email** to contact@robertbrooke.com

RBA Toilet Partition Style, Free Standing
 Fax: 1-800-642-2406 • P: 1-800-642-2403 • www.robertbrooke.com

Indicate desired HINGES:
 NO Doors
 Hinged on RIGHT
 Hinged on LEFT

Indicate desired SWING:
 NO Doors
 Swing OUT
 Swing IN

Please complete the information below:
 Date: _____ Your Name: _____
 Company Name: _____ Phone Number: _____
 Fax Number: _____ Email Address: _____
 Signature: _____

Select Material:
 Baked Enamel
 Plastic Laminate
 Solid Plastic
 Plastic Phenolic
 Stainless Steel

Please indicate Color (see website or visit color center)

Select Style (see website or visit color center)
 Overhead Braced
 Floor Mounted
 Ceiling Hung
 Floor to Ceiling

Overhead Braced | Floor Mounted | Ceiling Hung | Floor to Ceiling

Materials — Five are available



POWDER COATED STEEL

The industry standard. Most economical hybrid epoxy/polyester powder coated finish over galvanized steel with honeycomb core.



PLASTIC LAMINATE

Aesthetic appeal and economy. Pressure laminate smooth surface, resistant to grease and stains.



SOLID PLASTIC

The choice for busy public facilities, high density polyethylene (HDPE) polymer is highly resistant to stains, common acids and cleaning agents, as well as moisture, steam, and corrosion. Will not easily dent or chip.



STAINLESS STEEL

Gleaming beauty provides exceptional durability and modern styling. Available in #4 satin or textured finish.



PHENOLIC - BLACK CORE/COLOR THRU

Impact, moisture, and corrosion resistant, the surfaces are smooth and easy to clean. Ideal for extreme moisture conditions in showers, pools, and saunas, or when maintenance includes hosing down washrooms.

TOILET PARTITION DESIGN

Styles — Four are available

OVERHEAD BRACED/FLOOR ANCHORED

Units are recommended for heavy traffic and necessary vandalism-proof areas. Most economical. Anodized aluminum goes around top. They do not require any special floor construction, therefore they can be used in old or new buildings.



FLOOR MOUNTED

Absence of top structure prompts the use of these units in low ceiling areas. Gives modern, contemporary appearance. They require a 3" minimum concrete floor construction to secure anchor bolts.



FLOOR-TO-CEILING ANCHORED

Better than overhead braced for heavy traffic and vandalism-proof areas. Most stable as pilasters are anchored into concrete floor and structural ceiling support.

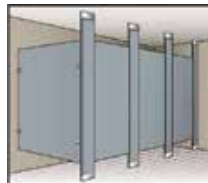

CEILING HUNG

Ceiling Hung is the best choice where minimizing maintenance is of primary importance. They provide a floor area free from obstruction to speed maintenance. However this design requires structural steel supports in the ceiling.



Layout – Examples

In-a-Corner



Between 2 Walls



Free Standing



Alcove



Toilet Partition Design

ASI Global Privacy Collection



TOILET PARTITION DESIGN

ASI Ultimate Privacy™ Sizes

Alpaco	Style	Mounting Configuration	<ul style="list-style-type: none"> • Door & Panel Height • Mounting Height 	Privacy Construction
Classic	European Style Phenolic Partitions	Floor Mounted Overhead Braced with Adjustable Pedestals	• 76-3/4" Doors & Panels • 6" or 9" Above Finished Floor	<ul style="list-style-type: none"> • Doors & Pilasters interlock with Zero-Sightline routed edges • PLUS, Continuous Brackets"
			• 78.6" Doors & Panels • 6" or 9" Above Finished Floor	
Elegance				
Material	Style	Mounting Configuration	<ul style="list-style-type: none"> • Door & Panel Height • Mounting Height 	"Privacy Construction
Stainless Steel OR Powder Coated Steel	Ultimate Privacy™	<ul style="list-style-type: none"> • Floor Mounted Overhead Braced • Floor Mounted 	<ul style="list-style-type: none"> • 58" Doors & Panels • 12" Above Finished Floor 	<ul style="list-style-type: none"> • No-Sight System, includes: - Continuous Strike Keeper - Continuous Hinge Side Filler • PLUS, Continuous Brackets
	Ultimate Privacy™ – 64	<ul style="list-style-type: none"> • Floor to Ceiling • Ceiling Hung 	<ul style="list-style-type: none"> • 64" Doors & Panels • 6" or 9" Above Finished Floor 	
	Ultimate Privacy™ – 72	<ul style="list-style-type: none"> • Floor Mounted Overhead Braced • Floor to Ceiling 	<ul style="list-style-type: none"> • 72" Doors & Panels • 6" or 9" Above Finished Floor 	
Phenolic	Ultimate Privacy™	<ul style="list-style-type: none"> • Floor Mounted Overhead Braced • Floor Mounted 	<ul style="list-style-type: none"> • 58" Doors & Panels • 12" Above Finished Floor 	<ul style="list-style-type: none"> • Doors & Pilasters interlock with Zero-Sightline™ routed edges • PLUS, Continuous Brackets OR • Continuous Strike Keeper • Continuous Hinge • PLUS, Continuous Brackets
	Ultimate Privacy™ – 64	<ul style="list-style-type: none"> • Floor to Ceiling • Ceiling Hung 	<ul style="list-style-type: none"> • 64" Doors & Panels • 6" or 9" Above Finished Floor 	
	Ultimate Privacy™ – 72	<ul style="list-style-type: none"> • Floor Mounted Overhead Braced • Floor to Ceiling" 	<ul style="list-style-type: none"> • 72" Doors & Panels • 6" or 9" Above Finished Floor 	
Solid Plastic (HDPE)	No slight – 55	<ul style="list-style-type: none"> • Floor Mounted • Floor to Ceiling • Ceiling Hung 	<ul style="list-style-type: none"> • 55" Doors & Panels • 14" Above Finished Floor 	<ul style="list-style-type: none"> • Continuous Strike Keeper • Continuous Hinge • PLUS, Continuous Brackets

Toilet Partition Design

Hadrian Privacy Collection



Material	Design Style	Mounting Options	Door & Panel Height Above Finished Floor(AFF)	Privacy Options
Powder Coated Steel	Standard	• Overhead Braced	• 58" Door & Panels	• Standard Hinges W/Hinge A Stop Gap Filler(Mandatory) • Optional Indicator Latch
		• Floor Mount	• 12" AFF	• Continuous SS Hinge
		• Floor to Ceiling		• Continuous Channels(Brackets)
		• Ceiling Hung		• Continuous Stop and Hinge Filler
	Elite	• Overhead Braced	• 64" Doors & Panels	• Standard Hinges W/Hinge A Stop Gap Filler(Mandatory)
		• Overhead Braced Pedestal Mount	• 9" or 6" AFF	• Continuous SS Hinge and Stop Gap Filler(Mandatory)
		• Floor Mount	• Floor Mount 9" AFF ONLY	• Continuous Channels(Brackets)
		• Floor to Ceiling		• Optional Indicator Latch
		• Ceiling Hung		
	Elite Plus	• Overhead Braced	• 72" Doors & Panels	• Standard Hinges W/Hinge A Stop Gap Filler(Mandatory)
		• Overhead Braced Pedestal Mount	• 9" or 6" AFF	• Continuous Channels(Brackets)
		• Floor to Ceiling	• 4" AFF for Pedestal Mount	• Optional Indicator Latch
		• Ceiling Hung		
	Elite Max	• Overhead Braced	• 73-92" Doors & Panels (1" Increments) • 9" AFF	• Standard Hinges W/Hinge A Stop Gap Filler(Mandatory)
		• Overhead Braced Pedestal Mount	• 6" FF for Overhead Braced and Floor to Ceiling	• Continuous Channels(Brackets)
		• Floor to Ceiling	• 4" AFF for Pedestal Mount	• Indicator Latch (Mandatory)
Stainless Steel	Standard	• Overhead Braced	• 58" Door & Panels	• Standard Hinges W/Hinge A Stop Gap Filler(Mandatory) • Optional Indicator Latch
		• Floor Mount	• 12" AFF	• Continuous SS Hinge
		• Floor to Ceiling		• Continuous Channels(Brackets)
		• Ceiling Hung		• Continuous Stop and Hinge Filler
	Elite	• Overhead Braced	• 64" Doors & Panels	• Standard Hinges W/Hinge A Stop Gap Filler(Mandatory)
		• Overhead Braced Pedestal Mount	• 9" or 6" AFF	• Continuous SS Hinge and Stop Gap Filler(Mandatory)
		• Floor Mount	• Floor Mount 9" AFF ONLY	• Continuous Channels(Brackets)
		• Floor to Ceiling		• Optional Indicator Latch
		• Ceiling Hung		
	Elite Plus	• Overhead Braced	• 72" Doors & Panels	• Standard Hinges W/Hinge A Stop Gap Filler(Mandatory)
		• Overhead Braced Pedestal Mount	• 9" or 6" AFF	• Continuous Channels(Brackets)
		• Floor to Ceiling	• 4" AFF for Pedestal Mount	• Optional Indicator Latch
		• Ceiling Hung		
	Elite Max	• Overhead Braced	• 73-92" Doors & Panels (1" Increments) • 9- AFF	• Standard Hinges W/Hinge A Stop Gap Filler(Mandatory)
		• Overhead Braced Pedestal Mount	• 6" FF for Overhead Braced and Floor to Ceiling	• Continuous Channels(Brackets)
		• Floor to Ceiling	• 4" AFF for Pedestal Mount	• Indicator Latch (Mandatory)
Solid Plastic (HDPE)	Standard	• Overhead Braced	• 55" Door A Panels	• Continuous SS Hinge • Optional Indicator Latch
		• Overhead Braced		• Continuous Stop(Alum)
		• Ceiling Hung		• Continuous Channels(Brackets) (Alum or SS)

TOILET PARTITION DESIGN

Powder Coated Steel Partitions

Complete Restroom Stalls



- **Very economical and often used.**
- Finish is a hard hybrid epoxy/polyester powder coated finish over rust resistant phosphate treated steel. With inner honeycomb core bonded to the steel with a non-toxic adhesive to ensure solid construction and sound attenuation. Assembled with a continuous roll-formed interlocking crown molding, with corners brazed and ground smooth.
- Doors, panels and urinal screens — 1" thick, 22 gauge steel. Doors and panels are 58" high.
- Pilasters — 1-1/4" thick, 20 gauge steel.
- Hardware — Cam action hinge permits door to remain at desired position when not in use. Hinges, strike and keeper, coat hook, latch, and brackets are chrome plated alloy. Concealed latch assembly allows for emergency access. Pilaster shoes are 304 stainless steel.
- Installation instructions, all mounting hardware and a can of touch up paint are supplied with each order.

Available Colors

Powder Coated Baked Enamel

Global All Orders Ship in 48 hours.

White #2129	Grey #2125	Charcoal #2123	Almond #2103	Khaki #2115	Dark Khaki #2109
Red #2145	Burgundy #2148	Sage #2141	Azure #2101	Royal Blue #2135	Black #2127
			Request a Manufacturer's color charts for more accurate color representation		
Metallic Silver #2171	Sandy Beach #2150	Pepper Dust #3590			

Hadrian Ships within 48 hrs of Order. — All Other Colors Ship in 2 to 3 weeks.

535 Light Grey	541 Extra White	603 Almond	607 Bordeaux	621 Slate
504 Linen	532 Latte	576 Ruby Red	545 Charcoal	500 White
585 Sahara	581 Moss Green	510 Black	639 Sapphire Blue	609 Colonial Blue
ANTI-GRAFFITI COLORS				
(SUBJECT TO UPCHARGE)				
833 Tricorn Black	828 Dovetail	829 Desert	826 Kilim Beige	
SPECIAL EFFECTS COLORS				
(SUBJECT TO UPCHARGE)				
837 Black Fox	831 Nickel Metallic	814 Cast Iron Metallic		

- Headrail braced toilet partitions available for Premium Quick Ship in USA; subject to upcharge
- Headrail braced, ceiling hung (9ft ceilings and lower) and floor mounted toilet partitions available for Quick Ship in USA.
- Headrail braced toilet partitions available for Quick Ship in Canada.

Privacy/Urinal Screens



WALL HUNG
1" thick by 48" high panel. Available in the following widths — 12, 18, 24 and 30". Specify — color and **Part No.** 9SWHS-XX (where XX is the screen width).



FLOOR & CEILING BRACED POST & PANEL
1-3/4" square post up to 120" maximum with 58" high panel. Specify — color, **Part No.** 9SFCS-XX-Y (where XX is width from the front of the post to the wall, Y = floor-to-ceiling height)*



OVERHEAD BRACED / FLOOR ANCHORED
Pilaster is braced by headrail to wall. Panel is 58" high. Pilaster is 82" high. Specify — color and **Part No.** 9S0BS-XX (where XX is width from the front of the pilaster to the wall*).



Floor Anchored
70" high pilaster and 58" high panel. Specify — color and **Part No.** 9SFAS-XX (where XX is width from the front of the pilaster to the wall)*.

* The overall width of the screen is 2" wider than the width of the panel.

Replacement

Doors

Includes: Hinges and All Hardware
Available for the following door opening widths (actual door size is 3/8" narrower than the opening): 20, 22, 24, 26, 28, 30, 32, 34, 36".
Specify —
• Color
• **Part No. 9TDS-XX** (where XX is door opening width)
• Pilaster type — Standard round edge, square edge or mounted on flat wall

Panels

Includes: 4 Brackets
Available in the following widths: 16, 22, 28, 34, 40, 46, 52, 55, 58, 60, 70 and 76".
Actual width is 1/2" less.
Specify —
• Color,
• **Part No. 9TPS-XX** (where XX is panel width).
• Reinforcing for grab bars available.

Pilasters

Includes: Brackets & Stainless Steel Shoes
Available in the following widths: 2, 3, 4, 5, 6, 7, 8, 10, 12, 16, 18, 20, 22 and 24".
Specify —
• Color,
• **Part No. 9TLS-XX** (where XX is pilaster width)
• Overhead braced for 82" (Hadrian) or 84" (Global) length, floor braced for 70" length, wall hung for 58" high, ceiling hung for 84" length, and floor-to-ceiling for up to 120" maximum length.

Aluminum Headrail

- For 1-1/4" Thick Pilasters
- Anti-Grip with 1/4" slot for curtain.
- Available in the following lengths:
Hadrian: 60", 74", 96"
Global: 65", 98"
Part No.
• **Hadrian:** 9HR60A, 9HR74A, 9HR98A
• **Global:** 9A8465114, 9A8498114

POWDER COATED STEEL PARTITIONS

Plastic Laminated Partitions

Complete Restroom Stalls

- Gives a more aesthetic appeal while maintaining economy.
- Fabricated from 45 pound density, resin impregnated particle board. Plastic laminate is glued to particle board with a non-toxic, water resistant adhesive under high pressure. Components are edge banded prior to face lamination to ensure moisture run-off and vandal resistance. Not recommended for high moisture areas.
- Doors, panels and urinal screens — 1" thick (uses 7/8" particle board)
- Pilasters — 1" thick (uses 7/8" particle board)
- Hardware — Gravity cam-action hinges permit door to remain at desired position when not in use. Hinges, strike and keeper, coat hook, latch and brackets are chromed plated alloy. Door can be lifted to allow emergency access.
- Installation instructions and all mounting hardware are supplied with each order.

Replacement

Doors

Includes: Hinges and All Hardware
 Available for the following door opening widths (actual door size is 3/8" narrower than the opening) — 22, 24, 26, 28, 30, 32, 34, and 36"
 Specify —
 • Color
 • **Part No. 9TDL-XX** (where XX is door opening width)

Panels

Includes: 4 Brackets
 Available in the following widths: 16, 22, 28, 34, 40, 46, 52, 55, 58, 60, 70 and 76".
 Actual width is 1/2" less.
 Specify —
 • Color,
 • **Part No. 9TPL-XX** (where XX is panel width).

Pilasters

Includes: Brackets & Stainless Steel Shoes
 Available in the following widths: 3, 4, 5, 6, 7, 8, 10, 12, 16, 18, 20, 22 and 24".
 Specify —
 • Color,
 • **Part No. 9TLL-XX** (where XX is pilaster width)
 • Overhead braced for 84" length, wall hung for 55" length and floor-to-ceiling for up to 116" maximum length.

Aluminum Headrail

• For 1" Thick Pilasters
 • Anti-Grip with 1/4" slot for curtain.
 • Available in the following lengths:
Global: 65", 98"
Part No.
 • **Global:** 9A84651, 9A84981

Privacy/Urinal Screens



WALL HUNG
 1" thick by 48" high panel. Available in the following widths — 12, 18, 24 and 30". Specify — color and **Part No. 9SWHL-XX** (where XX is the screen width).



FLOOR & CEILING BRACED POST & PANEL
 1-3/4" square post up to 120" maximum with 58" high panel. Specify — color, **Part No. 9SFCL-XX-Y** (where XX is width from the front of the post to the wall, Y = floor-to-ceiling height)*



OVERHEAD BRACED / FLOOR ANCHORED
 Pilaster is braced by headrail to wall. Panel is 58" high. Pilaster is 82" high. Specify — color and **Part No. 9SOBL-XX** (where XX is width from the front of the pilaster to the wall*).



Floor Anchored
 70" high pilaster and 58" high panel. Specify — color and **Part No. 9SFAL-XX** (where XX is width from the front of the pilaster to the wall).*

* The overall width of the screen is 2" wider than the width of the panel.

ASI Global Plastic Laminate Colors - 48 colors Ship in 48 Hours

Actual colors may vary slightly from those shown due to limitations in the printing process.

Mission White 1010	Almond 4000	Sand 4010	** Cotton Cloth 1681	Taupe 9096	** White Ash 1841
** Crisp Linen 1150	Fog 3450	Patine Bronze 4707	Washi Paperfold 5013	Green Felt 5974	Liquid Glass 6240
** Casual Linen 4538	** Satin Stainless 5030	Blue Felt 6320	** Wheat Strand 9110	Carrara Bianco 1096	** Burnt Strand 5107
** Antique Mango 9783	** Gray Linen 3750	** Aged Ash 9844	** Afternoon Nap 9120	Smoke 8450	** Little Black Dress 2100
** Love Letters 3003	** Soothing Pebble Beach 4109	Brittany Blue 7010	Navy Grafix 7318	Silver Gray 3000	Dove Gray 3010
Folkstone Celesta 3300	Canyon Zephyr 3713	** Handspun Pearl 3033	** Windswept Pewter 3849	Storm Solidz 3542	Graphite Graphix 3020
** Handspun Slate 3035	Smoke Quarstone 3350	Graphite 2150	Black 2000	** Handspun Chestnut 4036	** Flax Linen 4990
** Mahogany 9939	** Pewter Mesh 5993	** Asian Night 9550	** Weathered Ash 9842	** Neo Walnut 7954	** Kingswood Walnut 9218

** Directional Panel - Pattern on panels over 60" wide will run perpendicular to pattern on doors and pilasters. Pattern shown are cropped from the full sheet size, contact us for additional reference.

PLASTIC LAMINATED PARTITIONS

Solid Polymer Plastic Partitions

Complete Restroom Stalls

- **Designed for high-traffic public facilities, parks and schools.**
- The high-density polyethylene material has homogenous color throughout each component. Self-lubricating surface resists markings from pens, pencils, etc. Has low maintenance; good durability; water resistant, unaffected by steam or high humidity. Available in overhead braced/floor anchored and floor-to-ceiling anchored only.
- Doors, panels, pilasters and urinal screens — 1" thick, doors and panels are 55" high.
- Hardware — Available in hidden integral hinges or wrap around vault-type hinges. Cam-action hinge permits door to remain at desired position when not in use. Slide latch, striker and keeper, and coat hook are chrome plated alloy. Slide latch assembly allows for emergency access. Standard brackets are 54" long extruded PVC colored to match partitions. Pilaster shoes are molded plastic to match partitions. Stainless steel shoes and full height aluminum brackets are available at no up charge.
- Installation instructions and all mounting hardware are supplied with each order.

Privacy/Urinal Screens



WALL HUNG
1" thick by 48" high panel. Available in the following widths – 12, 18, 24 and 30". Specify – color and **Part No. 9SWHP-XX** (where XX is the screen width).



FLOOR & CEILING BRACED POST & PANEL
1-3/4" square post up to 120" maximum with 55" high panel. Specify – color, **Part No. 9SFCP-XX-Y** (where XX is width from the front of the post to the wall, Y = floor-to-ceiling height)*



OVERHEAD BRACED / FLOOR ANCHORED
Pilaster is braced by headrail to wall. Panel is 55" high. Pilaster is 82" high. Specify – color and **Part No. 9SOBP-XX** (where XX is width from the front of the pilaster to the wall*).

* The overall width of the screen is 2" wider than the width of the panel.



Request Manufacturer's color charts for more accurate color representation

Available Colors

Hadrian Solid Plastic 1 week shipping

High Density Polyethylene Colors (HDPE)

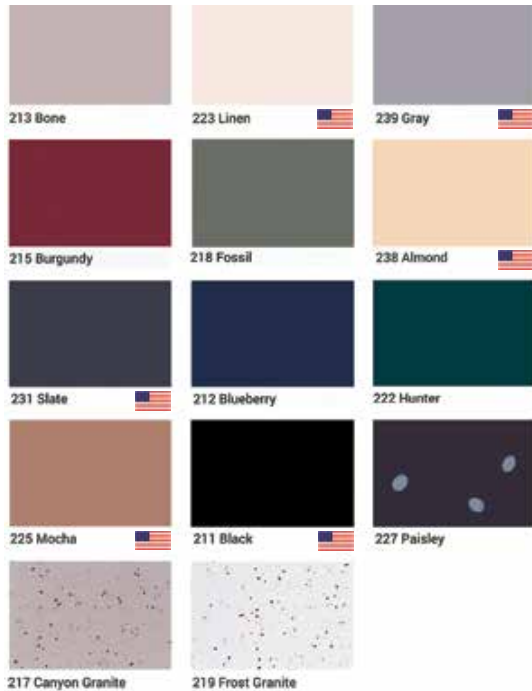

Headrail braced solid plastic toilet partitions stocked in the U.S.A.

Global Solid Polymer Plastic All COLORS SHIP IN 48 hours



* NOT Available in tough Texture™ or Hammered Finishes

Replacement

Doors

Includes: Hinges and All Hardware
Available for the following door opening widths (actual door size is 3/8" narrower than the opening): 20, 22, 24, 26, 28, 30, 32, 34, 36".
Specify —
• Color
• **Part No. 9TDP-XX** (where XX is door opening width)
• Pilaster type — Standard round edge, square edge or mounted on flat wall

Panels

Includes: 4 Brackets
Available in the following widths: 16, 22, 28, 34, 40, 46, 52, 55, 58, 60, 70 and 76".
Actual width is 1/2" less.
Specify —
• Color,
• **Part No. 9TPP-XX** (where XX is panel width).
• Reinforcing for grab bars available.

Pilasters

Includes: Brackets & Stainless Steel Shoes
Available in the following widths: 3, 4, 5, 6, 7, 8, 10, 12, 16, 18, 20, 22 and 24".
Specify —
• Color,
• **Part No. 9TLP-XX** (where XX is pilaster width)
• Overhead braced for 82" (Hadrian) or 84" (Global) length, floor braced for 70" length, wall hung for 58" high, ceiling hung for 84" length, and floor-to-ceiling for up to 120" maximum length.

Aluminum Headrail

- For 1" Thick Pilasters
- Anti-Grip with 1/4" slot for curtain.
- Available in the following lengths:
Hadrian: 60", 74", 96"
Global: 65", 98"

Part No.
• **Hadrian:** 9HR60SP, 9HR74SP, 9HR98SP
• **Global:** 9A84651, 9A84981

Stainless Steel Partitions

Complete Restroom Stalls

- Provides gleaming beauty, exceptional durability and modern styling.
- Type 304 stainless steel with a #4 finish bonded to an inner honeycomb core under pressure with a non-toxic adhesive to ensure solid construction and sound attenuation. Assembled with continuous roll-formed interlocking, 22 gauge stainless steel crown molding, with corners welded and ground smooth.
- Doors, panels and urinal screens — 1" thick, 22 gauge stainless steel.
- Pilasters — 1-1/4" thick, 22 gauge stainless steel.
- Hardware — Cam-action hinges permit door to remain at desired position when not in use. Hinges, strike and keeper, coat hook and latch are chrome plated alloy. Concealed latch allows for emergency access.
- Installation instructions and all mounting hardware are supplied with each order.

Privacy/Urinal Screens



WALL HUNG
1" thick by 48" high panel. Available in the following widths — 12, 18, 24 and 30". Specify — color and **Part No.** 9SWHSS-XX (where XX is the screen width).



FLOOR & CEILING BRACED POST & PANEL
1-3/4" square post up to 120" maximum with 58" high panel. Specify — color, **Part No.** 9SFCSS-XX-Y (where XX is width from the front of the post to the wall, Y = floor-to-ceiling height)*



OVERHEAD BRACED / FLOOR ANCHORED
Pilaster is braced by headrail to wall. Panel is 58" high. Pilaster is 82" high. Specify — color and **Part No.** 9S0BSS-XX (where XX is width from the front of the pilaster to the wall*).



Floor Anchored
70" high pilaster and 58" high panel. Specify — color and **Part No.** 9SFASS-XX (where XX is width from the front of the pilaster to the wall)*.

* The overall width of the screen is 2" wider than the width of the panel.

Urinal Splash Plates



Stainless Steel

- Cover panels or screens near urinal.
- Stainless steel.
- Attach with rivets.

HEIGHT	WIDTH	PART NO.
41"	16"	9TUSP16
41"	22- 1/2"	9TUSP22
36"	24"	9TUSP24
36"	30"	9TUSP30
36"	36"	9TUSP36



#4 Brushed Stainless Steel

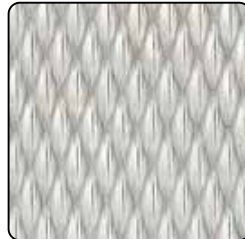

Embossed Stainless Steel/
Diamond Pattern



STAINLESS STEEL PARTITIONS

Replacement

Doors

Includes: Hinges and All Hardware
Available for the following door opening widths (actual door size is 3/8" narrower than the opening): 20, 22, 24, 26, 28, 30, 32, 34, 36".
Specify —
• Color
• **Part No. 9TDSS-XX** (where XX is door opening width)
• Pilaster type — Standard round edge, square edge or mounted on flat wall

Panels

Includes: 4 Brackets
Available in the following widths: 16, 22, 28, 34, 40, 46, 52, 55, 58, 60, 70 and 76".
Actual width is 1/2" less.
Specify —
• Color,
• **Part No. 9TPSS-XX** (where XX is panel width).
• Reinforcing for grab bars available.

Pilasters

Includes: Brackets & Stainless Steel Shoes
Available in the following widths: 2, 3, 4, 5, 6, 7, 8, 10, 12, 16, 18, 20, 22 and 24".
Specify —
• Color,
• **Part No. 9TLSS-XX** (where XX is pilaster width)
• Overhead braced for 82" (Hadrian) or 84" (Global) length, floor braced for 70" length, wall hung for 58" high, ceiling hung for 84" length, and floor-to-ceiling for up to 120" maximum length

Aluminum Headrail

• For 1-1/4" Thick Pilasters
• Anti-Grip with 1/4" slot for curtain.
• Available in the following lengths:
Hadrian: 60", 74", 96"
Global: 65", 98"
Part No.
• **Hadrian:** 9HR60A, 9HR74A, 9HR98A
• **Global:** 9A8465114, 9A8498114

Solid Phenolic Partitions

Complete Restroom Stalls

- **Ideal for extreme moisture conditions in showers, pools and saunas. Surfaces are smooth and easy to clean.**
- Phenolic material is comprised of multiple layers of melamine resin impregnated kraft paper to give a black core and a decorated surface sheet on both faces. All layers are fused together under high pressure. Material of choice where durability and strength are required. Uses stainless steel brackets. Impact and corrosion resistant; does not support bacteria.
- Doors and pilasters — 3/4" thick
- Panels and urinal screens — 1/2" thick
- Hardware — Cam-action hinge permits doors to return to a preset position when not locked. Hinges, strike and keeper are brushed aluminum. Cam-action hinge allows emergency access by lifting door.
- Installation instructions and all mounting hardware are supplied with each order.

Replacement

Doors

Includes: Hinges and All Hardware
Available for the following door opening widths (actual door size is 3/8" narrower than the opening): 20, 22, 24, 26, 28, 30, 32, 34, 36".
Specify —

- Color
- **Part No. 9TDPH-XX** (where XX is door opening width)
- Pilaster type — Standard round edge, square edge or mounted on flat wall

Panels

Includes: 4 Brackets
Available in the following widths: 16, 22, 28, 34, 40, 46, 52, 55, 58, 60, 70 and 76".
Actual width is 1/2" less.
Specify —

- Color,
- **Part No. 9TPPH-XX** (where XX is panel width).
- Reinforcing for grab bars available.

Pilasters

Includes: Brackets & Stainless Steel Shoes
Available in the following widths: 2, 3, 4, 5, 6, 7, 8, 10, 12, 16, 18, 20, 22 and 24".
Specify —

- Color,
- **Part No. 9TLPH-XX** (where XX is pilaster width)
- Overhead braced for 84" length, floor braced for 70" length, wall hung for 58" high, ceiling hung for 84" length, and floor-to-ceiling for up to 120" maximum length.

Aluminum Headrail

- For 3/4" Thick Pilasters
- Anti-Grip with 1/4" slot for curtain.
- Available in the following lengths:
Part No.
- **Global:** 9A846534, 9A84983

Global Solid Phenolic Colors

"Color-Thru" Phenolic

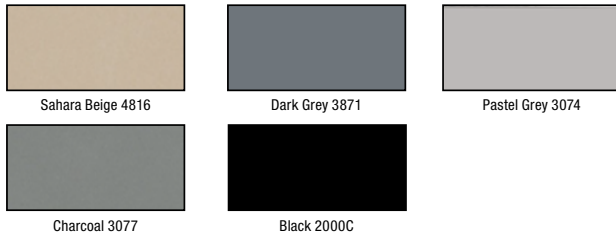

Standard Black Core Colors

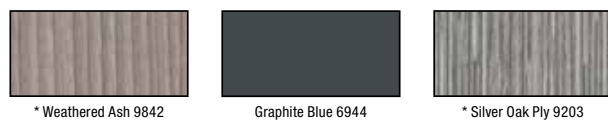

Request Manufacturer's color charts for more accurate color representation

- *** Color-Thru Phenolic: 2 to 3+ weeks**
- *** Black Core: 1 to 2+ weeks (includes Black 2000C)**

Head Rails

Specification Sheet, Other Materials & Model Types Available

TYPE A HEADRAIL

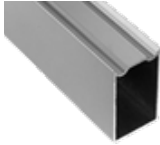

PILASTER THICKNESS	LENGTH	PART NO.
1-1/4"	60"	9HR60A
	74"	9HR74A
	96"	9HR96A

TYPE B HEADRAIL



PILASTER THICKNESS	LENGTH	PART NO.
3/4"	65"	9THPH *SELECT SIZE: 9THPH-65
	95"	9THPH *SELECT SIZE: 9THPH-95
1"	65"	9HR75B1
	95"	9HR98B1
1-1/4"	65"	9HR62B2
	95"	9HR98B2

ASI HEADRAIL



PILASTER THICKNESS	LENGTH	PART NO.
3/4"	65"	9A846534
	98"	9A849834
1"	65"	9A84651
	98"	9A84981
1-1/4"	65"	9A8465114
	98"	9A8498114

ASI HEADRAIL RETURN KIT

Part No. 9A8448



HADRIAN HEADRAIL FOR SOLID PLASTIC



PILASTER THICKNESS	LENGTH	PART NO.
1"	60"	9HR60SP
	74"	9HR74SP
	96"	9HR96SP

HADRIAN HEADRAILS BRACKET OPTIONS AVAILABLE



Grab Bars



ADA ACCESSIBLE COMPARTMENT REQUIRE:

1-1/4" or 1-1/2" Dia. bars, at least a 42" long on side and at least a 36" long behind the toilet.
(Most popular are 36" and 42" long, 1-1/2" diameter, concealed set screws.)

- In compliance with strength requirements of ADA guidelines.
- Bars are fabricated of a satin finish 18 Gauge type 304 stainless steel tubing.
- Available peened or smooth.
- Mandrell bending process ensures uniform bar diameters.
- Heliarc welding forms a single structural unit.



STRAIGHT BARS

PART NO.	LENGTH
K7410	12"
K7412	18"
K7413	24"
K7415	42"
K7416	36"
K7417	48"



Specify Part Number, Flange Type, 1-1/4" or 1-1/2" Diameter when ordering



STRAIGHT BARS WITH CENTER POST

PART NO.	LENGTH
K7415C	42"
K7416C	36"
K7417C	48"

Choose One of 2 Flange Types

EXPOSED MOUNTING

- Flange is 3" diameter, 1/8" thick type 304 stainless steel with satin finish.
- Exposed mounting screw holes are drilled and countersunk.

SNAP FLANGE

- Cover snaps over mounting flange dimples to conceal screws.
- Concealed mounting flange is 3-1/8" O.D. diameter with two screw holes and three locking dimples and is 1/8" thick, type 304 stainless steel.
- Cover is type 304 stainless steel with satin finish, 22 gauge, 3-3/16" diameter.



More styles also available

Grab Bars for Toilet Stools

SWING-UP GRAB BAR

Locks firmly into place when lifted into an upright position 1-1/4" O.D.
Model No. 3410



Left Hand, Model No. 2257
Right Hand, (shown) Model No. 2256

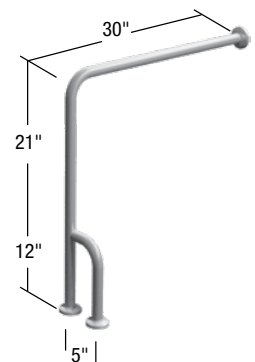

SIDE-GRAB BAR

Model No. 7472

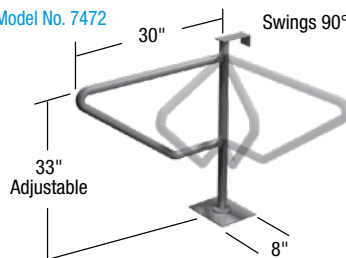

TYPE 34

Model No. 2234

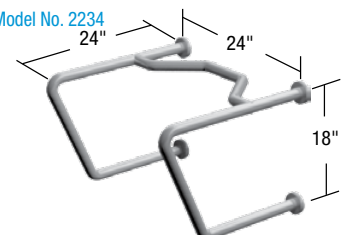

Restroom Accessories

T-Paper Holders



ROLL TYPE CHROME
Part No. 9A0330



DOUBLE ROLL CHROME
Part No. 9A0965



SINGLE ROLL – Deluxe CHROME
Part No. 9AT815



FOR 4 1/2" wide Rolls ONLY



DOUBLE ROLL – Deluxe CHROME
Part No. 9AT830



KEYED 2 ROLL TYPE
Surface Mounted with Keyed Lock
6" w x 13" h x 6" d
Stainless Steel Part No. 9A0311
Heavy White Metal Back
White Plastic Front Part No. 9AR25W
Heavy Black Metal Back
Transparent Plastic Front Part No. 9AR25T



SINGLE ROLL TYPE
CONTROL-O-ROL
Controlled Tissue Flow.
Controlled Tissue Flow.
Tough ABS Plastic.
Tension Spring
Part No. 9A0270



DOUBLE ROLL TYPE CONTROL-O-ROL
Controlled Tissue Flow.
Tough ABS Plastic. Tension Spring
Part No. 9A2270



BOBRICK SINGLE ROLL TYPE
Part No. B273



BOBRICK SINGLE ROLL TYPE
Part No. B274



BOBRICK REPLACEMENT SPINDLE
273, 274, 2730, 2740, 27466
Part No. B273-103



REPLACEMENT SPINDLE
(Used on the 9A0311)
5-5/16" Long x 7/16" Axle Dia.
Part No. 9A0312

9" Jumbo Rolls

- Universal All Brand 9" Jumbo Tissue with 3-3/8" Cores
- White Impact Resistant Plastic Back
- **STAINLESS STEEL ALSO AVAILABLE**



SINGLE

FRONT COLOR	PART NO.
DARK TRANSLUCENT	9AR26T
WHITE	9AR26W



TWIN

FRONT COLOR	PART NO.
DARK TRANSLUCENT	9AR27T
WHITE	9AR27W

Disposable Toilet Seat Covers and Dispensers

DISPENSERS – 250 Seat Cover Capacity



SURFACE MOUNTED UNKEYED
16-3/4" x 12-5" x 2.62"
White:
Part No. 9ASE01
Black: (Shown)
Part No. 9ASE02
Stainless Steel
Part No. 9ASE03



RECESSED KEYED
18" X 21" X 3"
Stainless Steel
Part No. 9ASE04



COVERS
18" x 15" – Bright White
2500 Case Size
Part No. 9ASE11
5000 Case Size
Part No. 9ASE12

Toilet Seats

Solid Colored Plastic – Heavy Duty For Commercial & Institutional Use.



LIFT –
HANDICAPPED adds Lift

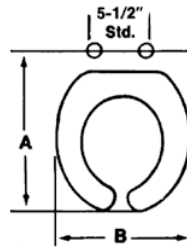
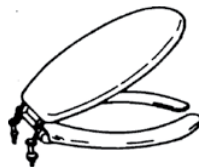

SEAT ATTACHING HOLES

HANDICAPPED

LIFT	"B" Elongated	Cover Width	Color*	Part No.
2"	Elongated	No	White	9ASE70
3"	Elongated	No	White	9ASE75

NON-HANDICAPPED

"A" LENGTH	"B" WIDTH	COVER	COLOR*	PART NO.
ELONGATED BOWL 18 - 3/8"	14-1/8"	YES	WHITE	9ASE10
	15-1/4"	NO	WHITE	9ASE20
		BLACK	9ASE30	
REGULAR BOWL 16 - 3/4"	14-1/2"	YES	WHITE	9ASE40
		NO	WHITE	9ASE50
	BLACK	9ASE60		

Koala Care



- Oval Horizontal Mount
 - Anti-Microbial (Microban)
 - Colors: Grey, Sandstone
- Part No. KB208



- Horizontal Mount
 - Anti-Microbial (Microban)
 - 25 Liner Holder
 - Colors: Grey, Beige, White Granite
- Part No. KB300



- Horizontal Mount
 - Anti-Microbial (Microban)
 - 25 Liner Holder
 - Stainless Steel Face Plate
 - Colors: Grey, White Granite
- Part No. KB300SS

Restroom Accessories

American Specialties, ASI



- Horizontal Surface Mount
 - FDA Approved Fungus and Bacteria-Resistant Plastic
 - Stainless Steel Face and Collar
- Part No. 9A90189



- Horizontal Recessed Mount
 - FDA Approved Fungus and Bacteria-Resistant Plastic
 - Stainless Steel Face and Collar
- Part No. 9A9018

Diaper Depot Changing Station



COLOR	PART NO.
Powder Gray	9RSS1P
Ivory	9RSS1I
White	9RSS1W

- Attractive, durable, safe, affordable
- Combines durability with long lasting looks
- Universal Safety instructions
- Dual dispensers for liners
- 4" depth closed; 20" depth open; 34" wide
- Fully hidden gas shock
- Shelf for personal changing items
- Safe Strap safety belt
- Molded in hook for purse or diaper bag
- Concave bed
- Includes Industrial grade hardware kit for easy installation
- Warranted to be free from defects in material and workmanship for up to five years

Soap Dispensers

Specification Sheet, Other Models & Types Available

Bobrick



SURFACE MOUNTED SOAP DISPENSER

- Translucent container provides visible soap level
 - For both Liquid & Lotion Soaps
 - Hand actuated
 - 5-13/16" w x 6-7/8" h x 3-3/16" d
 - 40 oz. Capacity
- Part No. B40



SURFACE MOUNTED SOAP DISPENSER

- Impact Resistant
 - For both Liquid & Lotion Soaps
 - Hand actuated
 - 6" w x 8-1/8" h x 4" d
 - 50 oz. Capacity
- Part No. B5050

Baby Changing Station



- Surface Mounted — 4" Depth (closed)
- ADA Compliant
- Sturdy Child Protection — 300 lb. load capacity
- Easy Opening and Closing
- Constructed of 100% High-density Polyethylene
- Easily cleaned, gray color

Part No. 9R104

Mills



STAINLESS STEEL VERTICAL SOAP DISPENSER

- 5" w x 8" h x 3" d
- 40 oz. Capacity

SOAP	PART NO.
LIQUID	9A0444



STAINLESS STEEL HORIZONTAL SOAP DISPENSER

- 8" w x 5" h x 3" d
- 40 oz. Capacity

SOAP	PART NO.
LIQUID	9A0333

EYE GLASS REPLACEMENT for the 300/400 series soap dispensers
Part No. 9A0300E

General and ADA Soap Dispensers



TOUCH-FREE UNIVERSAL ELECTRONIC SOAP DISPENSER

- Impact Resistant
 - 3-Cell Alkaline Batteries Provide 10,000 Dispenses of 1 Drop of Soap
 - Hand actuates by breaking electronic beam
 - 4" w x 11" h x 5" d
 - 27 oz. Capacity
- Part No. 9SE800W



PLASTIC LIQUID/LOTION SOAP DISPENSER

- Impact Resistant
- Dark Translucent Plastic
- Large Push Bar Meets ADA Requirements
- 5" w x 6" h x 4" d

CAPACITY	PART NO.
30 oz	9AS30T
46 oz	9AS46T



STAINLESS STEEL HORIZONTAL ALL PURPOSE SOAP DISPENSER

- For both Liquid & Lotion Soaps
- 8" w x 5" h x 5" d
- 40 oz. Capacity

Part No. 9A0345



SURFACE MOUNTED SHELF AND SOAP DISPENSER

- For both Liquid & Lotion Soaps
- Satin Finish Stainless Steel
- 20" w x 3" h x 5" d
- 80 oz. Capacity

Part No. 9A0318



STAINLESS STEEL VERTICAL ALL PURPOSE SOAP DISPENSER

- For both Liquid & Lotion Soaps
 - 5" w x 8" h x 5" d
 - 40 oz. Capacity
- Part No. 9A0347



LAVATORY MOUNTED SOAP DISPENSER

- Dispenses Viscous Lotion Soaps and synthetic detergents
 - Spout & Stem are Polished Stainless Steel
 - 34 oz. Capacity
- Part No. 9A0332

Soap Dispenser Valve Assemblies



*Valve threads are 3/4" O.D.
28 Threads per inch.

SOAP DISPENSER	VALVE PART NO.
9A0333	9A035C*
9A0444	9A035C*
9A0500	9AV500
ALL PURPOSE	9AV320

Restroom Accessories

Paper Towel Dispensers



STAINLESS STEEL MULTI-TOWEL

- Tumbler Lock, Stainless Steel and Heavy Duty Piano Hingel
- Holds 525 Multi-fold or 400 C-fold Towels
- Holds Rolls up to 8" wide non-perforated roll
- 11" w x 15" h x 4" d

Part No. 9AT0210



C-FOLD, MULTI-FOLD PAPER TOWEL DISPENSER

- Heavy Gauge Steel Back with Impact Resistant Plastic Front
- Holds 540 Multi-fold or 335 C-fold Towels
- 11" w x 15" h x 4" d

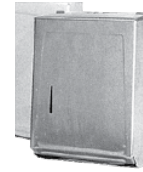

C-FOLD, MULTI-FOLD METAL PAPER TOWEL DISPENSER

- Tumbler Lock, Sheet Metal and Heavy Duty Piano Hinge
- Holds 525 Multi-fold or 400 C-fold Towels
- 11" w x 15" h x 4" d

COVER COLOR	PART NO.
WHITE	9AT175W
DARK TRANSLUCENT	9AT175T

ITEM	PART NO.
WHITE ENAMEL	9AT130
CHROME PLATED	9AT130C
STAINLESS STEEL	9AT0210



C-FOLD, MULTI-FOLD SMALL METAL PAPER TOWEL DISPENSER

- Tumbler Lock, Stainless Steel and Heavy Duty Piano Hinge
- Holds 275 Multi-fold or 200 C-fold Towels
- 11" w x 8" h x 4" d

Part No. 9AT0215



ROLL TYPE - FULL WIDTH LEVER ACTION TOWEL DISPENSER

- Heavy Gauge Steel Back with Impact Resistant Plastic Front
- For Rolls 8" w x 8" dia.
- 11" w x 16" h x 9" d

COVER COLOR	PART NO.
WHITE	9AT215W
DARK TRANSLUCENT	9AT215T



ROLL TYPE, CRANK TOWEL DISPENSER

- Holds Rolls 8" w x 500'
- Dent Resistant White Enamel Steel

Part No. 9AT675



ROLL TYPE - NO TOUCH ELECTRIC TOWEL DISPENSER

- Heavy Gauge Steel Back with Impact Resistant Plastic Front
- For Rolls 8" w x 8" dia.
- Towels are Dispensed Automatically When Hands are Placed Below Dispenser
- 11" w x 16" h x 9" d

COVER COLOR	PART NO.
DARK TRANSLUCENT	9AT225T



ROLL TYPE - BOTTOM PULL TOWEL DISPENSER

- Translucent Impact Resistant Plastic Front
- For Rolls 8" w x 8" dia.
- 11" Sheet via. Auto-Cut Mechanism
- 11" w x 16" h x 9" d

Part No. 9AT400T



ROLL TYPE - SELF-ADJUSTING CENTER PULL DISPENSER

- Impact Resistant Plastic
- Holds Rolls up to 9" dia x 9" tall
- 10" w x 12" h x 10" d

COVER COLOR	PART NO.
WHITE	9AT255W
DARK TRANSLUCENT	9AT255T

Towel Cabinet Selector Guide

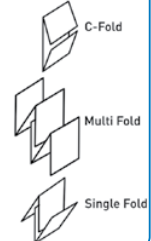

Electric Air Dryer

American Specialties, ASI



TURBO DRI HIGH SPEED DRYER

- Heavy Duty Stainless Steel Housing
- Infrared sensor
- 12 second dry time
- 60 second shut off
- 120 Thru 240 Voltage
- Surface Mounted
- Sound level: 65dB to 78dB
- 8-1/16" w x 12" h x 7-5/64" d
- Colors: Bright SS, Satin SS, White

Part No. 9A0197



TURBO DRI (JR.) HIGH SPEED DRYER

- Heavy Duty Stainless Steel Housing
- Infrared sensor
- 15 second dry time
- 60 second shut off
- 120 Thru 240 Voltage
- Surface Mounted
- Sound level: 66dB
- 9-25/32" w x 6-5/8" h x 5-13/32" d
- Satin SS

Part No. 9A0198

Bobrick



QUIET-DRY ADA HAND DRYER

- 115 Thru 230 Voltage
- Surface Mounted
- Infrared Sensor
- 13-25/32" w x 13-19/32" h x 4" d
- Satin SS or White Finish

Part No. B712

Alpine



HEMLOCK HAND DRYER

- 110/120 or 220/240 Voltage
- Hardwire or Plug-in
- Surface Mounted
- Infrared Sensor
- 11-13/32" w x 12-5/16" h x 6-11/16" d
- Colors: Black, Chrome, Coffee, Gray, Red, Brushes SS, White Finish

Part No. 9A400

Restroom Accessories

Paper Towel Dispensers & Waste Receptacles

Specification Sheet, Other Models & Types Available



C-FOLD, MULTI FOLD TOWEL DISPENSER & WASTE RECEPTACLE

- 22 Gauge Type 304 Stainless Steel
- Heavy Duty Door and Piano Hinge
- Tumble Lock on Doors and Waste Receptacle
- 600 C-Fold or 800 Multi Fold Towels Capacity
- 12 Gallon Waste Receptacle
- 15" w x 54" h x 4" d

ITEM	PART NO.
SURFACE MOUNTED	9A04699
SEMI RECESS MOUNTED	9A04692
RECESSED	9A0469



C-FOLD, MULTI FOLD PAPER TOWEL DISPENSER

- 22 Gauge Type 304 Stainless Steel
- Heavy Duty Door and Piano Hinge
- Tumble Lock on Doors
- 600 C-Fold or 800 Multi Fold Towels Capacity
- 13" w x 26" h x 4" d

ITEM	PART NO.
SURFACE MOUNTED	9A05429
RECESSED	9A0452

NOTE: 350 C-Fold / 475 Multi Fold Available



WASTE RECEPTACLE

- 22 Gauge Type 304 Stainless Steel
- Top and Bottom Edges Hammered for Safety
- 12 Gallon Receptacle. Other Sizes Available

ITEM	SIZE	PART NO.
SURFACE MOUNTED	16"W X 29"H X 7"D	9A04589
FREE STANDING	16"W X 23"H X 8"D	9A0826
RECESSED	16"W X 29"H	9A0458



DUAL SANITARY NAPKIN/TAMPON DISPENSER

- #4 Satin Finish Stainless Steel
- 2 Separate/Independent Mechanisms
- 30 Napkin, 27 Tampon Capacity
- Settings: Free, .05, .10, .25, .50 coinage

ITEM	PART NO.
SURFACE MOUNTED	9AU527
RECESSED	9AU526



SURFACE MOUNTED SANITARY NAPKIN DISPOSAL & BAGS

- Piano Hinge Cover
- 8" w x 11" h x 4" d

ITEM	PART NO.
STAINLESS STEEL	9A4101
KRAFT (WAX COATED) REFILL BAGS (500 COUNT)	9A4101B



PARTITION & IN-WALL SANITARY NAPKIN/TAMPON DISPOSAL

- #4 Satin Finish 304 Stainless Steel
- Partition Unit Serves 2 Compartments Mounting in Panel
- Recessed for Side Wall Use

ITEM	PART NO.
PARTITION DUAL ACCESS	9A0472
RECESSED IN-WALL	9A0473

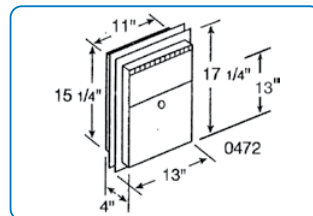

**Contact Us for
Additional
Restroom Accessory
Options**

RESTROOM ACCESSORIES

Restroom Accessories

ADA Braille Directional Signs



Plexiglass with polished edges.
12" Dia.

Part Nos.

Women – 9R840

Men – 9R840A

Restroom – 9R840B



Pressure sensitive 6"x6"
(152 mm) international
handicap symbol white
on blue

Part No. 9R840C



Tactile signs comply with the signage
requirements of the American
with Disabilities Act. Durable plastic
with Grade 2 Braille. 6"x 8",

Part Nos. Women – 9R840T

Men – 9R840AT

Restroom – 9R840BT

Mirrors

CHANNEL FRAME PLATE GLASS MIRROR

- 1/2" x 1/2" x 1/2" One Piece Channel
- Type 304 Satin Finish Stainless Steel
- 15 Year Warranty Against Silver Spoilage
- Includes bracket for Easy Secure Installation

Part No.	Width	Height	Part No.	Width	Height
9TM535	16"	20"	9TM655	24"	48"
9TM639	16"	24"	9TM624	24"	60"
9TM550	16"	30"	9TM626	36"	24"
9TM537	18"	24"	9TM660	36"	48"
9TM640	18"	30"	9TM627	48"	24"
9TM541	18"	36"	9TM670	48"	36"
9TM650	24"	24"	9TM628	60"	24"
9TM641	24"	30"	9TM680	60"	36"
9TM623	24"	36"	9TM690	72"	36"



! Also available
with shelves

FIXED ANGLE TILT MIRROR

- Offers Visibility for Wheel Chair Users
- 20 Gauge Satin Finish Stainless Steel Frame
- Mirror Tapers from 4" at Top to 1" at Bottom
- 15 Year Warranty Against Silver Spoilage
- 4 Keyhole Slots in Back of Mirror Unit Connect to Screws in Wall

Part No.	Width	Height
9A535	16"	30"
9A5351	18"	24"
9A5353	18"	30"
9A5355	18"	36"
9A5357	24"	30"
9A5359	24"	36"



ADJUSTABLE TILT MIRROR

- Offers Visibility for Wheel Chair Users or Returns to Upright Position
- 18 Gauge Stainless Steel Frame
- Tilts Full 6"
- 15 Year Warranty Against Silver Spoilage
- Stainless Steel Hinge Pivot Brackets and Piano Hinge Attached Mirror to Wall

Part No.	Width	Height	Part No.	Width	Height
9A600T	16"	24"	9A600T5	18"	36"
9A600T1	16"	30"	9A600T7	24"	30"
9A600T2	18"	24"	9A600T9	24"	36"
9A600T3	18"	30"			



FRAMELESS STAINLESS STEEL MIRROR

- 20 Gauge Stainless Steel Polished to a #8 Mirror Finish
- 1/4" thick Concealed Tempered Masonite Backing with Holes in Each Corner for Mounting. Customer Supplies Screws

Part No.	Width	Height
9A8026	16"	20"
9A80261	16"	24"
9A80262	18"	24"
9A80263	18"	30"
9A80265	24"	30"
9A80267	24"	36"
9A80269	48"	24"



RESTROOM ACCESSORIES

Stainless Steel Shelving

ECONOMY SHELVES

LENGTH	Part No.		
	5" Depth	6" Depth	8" Depth
12"	9TS538x12	9TS638x12	9TS838x12
16"	9TS538x16	9TS638x16	9TS838x16
18"	9TS538x18	9TS638x18	9TS838x18
24"	9TS538x24	9TS638x24	9TS838x24
30"	9TS538x30	9TS638x30	9TS838x30
36"	9TS538x36	9TS638x36	9TS838x36
48"	9TS538x48	9TS638x48	9TS838x48
60"	9TS538x60	9TS638x60	9TS838x60
72"	9TS538x72	9TS638x72	9TS838x72



- Fabricated with Satin Finish Stainless Steel
- Premium shelves

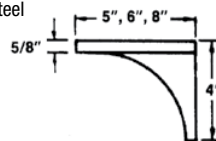

! Specification Sheets are
available for all products

FOLDING UTILITY Shelf

Part No. 9A0698



- 14-5/8" X 5-13/16"
Upright position when not
in use.

Restroom Accessories

Toilet Partition Hardware Fasteners

All Fasteners are Chrome Plated

One-Way Shoulder Screw & Barrel Nut

10-24 Thread



PART NO.	GRIP RANGE
9SS075	3/4" – 7/8"
9SS087	7/8" – 1-1/16"
9SS106	1-1/16" – 1-5/16" 1" door slide bolt latches 1" panel brackets
9SS131	1-5/16" – 1-5/8" 1-1/4" Pilaster brackets, keeper bumpers & hinges

Torx (T-27) Shoulder Screw & Barrel Nut

10-24 Thread



PART NO.	GRIP RANGE
9SS075T	3/4" – 7/8"
9SS087T	7/8" – 1-1/16"
9SS106T	1-1/16" – 1-5/16" 1" door slide bolt latches 1" panel brackets
9SS131T	1-5/16" – 1-5/8" 1-1/4" Pilaster brackets, keeper bumpers & hinges

One-Way Sheet Metal Screws

Chrome Plated Steel Available 100/Box

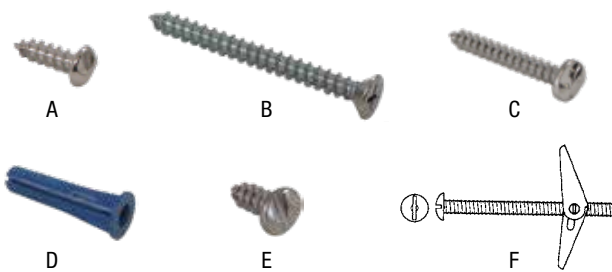

	PART NO.	DESCRIPTION	USE
A	9A7022	#10 x 5/8 long - 11/32 dia. head, 3/16 dia. thread	Coat Hooks, #9F0217 Slide Bolt Latch, #9F0211N & #9F0214N Hinges
B	9A7087	#10 x 1" long - 3/16" dia., Phillips Tapered head	Door Inserts, Cam Housings, Flat Keeper Bumpers
C	9A7073	#12 x 1-1/2" long-13/32 dia. head 7/32 dia., thread	Bracket to wall
D	9A0121	#12 x 1" Plastic Plug Anchor	#9A7073 & 9A91813 Screws
E	9A7040	#14 x 5/8" long -15/32 dia., head, 1/4 dia. thread	Bracket to Panel & Bracket to Pilaster #9S7531 Throw Latch
F	9A7010	#10 x 3" Long - 7/16 dia.	Attaches brackets to drywallhead toggle

Torx (T-27) Sheet Metal Screws

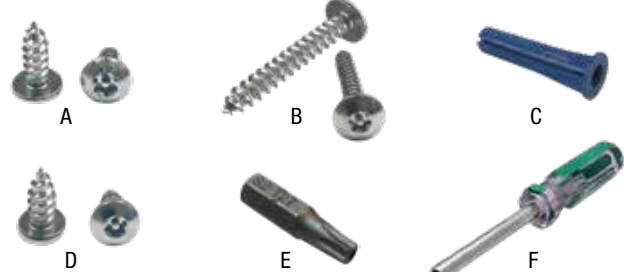

	PART NO.	DESCRIPTION	USE
A	9A90963	#10 x 5/8 long - 11/32 dia. head, 3/16 dia. thread	Coat Hooks, #9F0217 Slide Bolt Latch, #9F0211N & #9F0214N Hinges
B	9A91813	#12 x 1-1/2" long-13/32 dia. head 7/32 dia., thread	Bracket to wall
C	9A0121	#12 x 1" Plastic Plug Anchor	#9A7073 & 9A91813 Screws
D	9A92193	#14 x 5/8" long -15/32 dia., head, 1/4 dia. thread	Bracket to Panel & Bracket to Pilaster #9S7531 Throw Latch
E	TBIT	T-27 Driver Bit	Used for Fastening Torx Screws, 1/4" Shank
F	9A8965	Driver Tool	Used for Holding Driver Bits

RESTROOM ACCESSORIES

UN-DO-IT

For Removing One-Way Screws



	Part No.
For #12 & #14 Screws	9A0810
For #8 & #10 Screws	9A0807
For #6 & #8 Screws	9A0804
Three-Pack One of each	9A0801



Restroom Accessories

American Specialties – Matte Black Collection

All Products are Constructed of Stainless Steel with Matte Black Powder Coating Finish



- Liquid Soap
 - 40 oz.
 - Vertical
- Part No. B10-0347-41



- 1 Single Roll
- Part No. B10-7305-41



- 400 C-Fold or 525 Multi-fold
 - Tumbler Lock
 - Surface Mount
- Part No. B10-0210-41



- Liquid Soap
 - 40 oz.
 - Horizontal
- Part No. B10-0345-41



- 2 Standard Rolls
- Part No. B10-7305-2-41

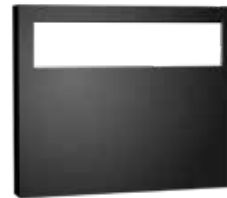

- Dispenses 250 Single or Half-fold Seat Covers
 - Surface Mount
- Part No. B10-0477-SM-41



- Liquid Soap
 - 48 oz.
- Part No. B10-9343-41



- 2" Projection
 - Surface Mount
- Part No. B10-7340-41



- Hinged Lid
 - 1.2 Gallon Capacity
 - Surface Mount
- Part No. B10-0852-41



- Liquid Soap
 - 10" Roll
 - Tumbler Lock
- Part No. B10-0042-41



- Surface Mount
 - Snap Flange
 - 1-1/2" Diameter
 - Sizes:
 - 18"
 - 24"
 - 24"
 - 36"
 - 42"
- Part No. B10-3801



- Surface Mount
 - Concealed Hanging Bracket
 - Tamper Proof Screws
 - Plated Glass
 - Sizes:
 - 18"W x 36"H
 - 24"W x 36"H
- Part No. B10-0600



**Additional Matte Black Products are Available.
Please contact Us for More Information**

Toilet Partition Hardware

Accurate – Chrome Plated Hardware



Current
ACCURATE POWDER
COATED STEEL IN
SWING DOOR KIT
Part No.
9A85-13513



 ACCURATE OUT
SWING DOOR KIT
Part No.
9A85-13514

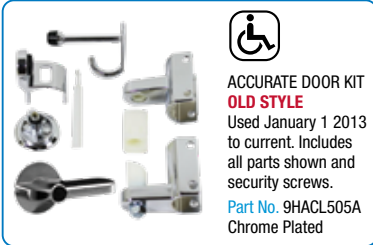

 ACCURATE DOOR KIT
OLD STYLE
Used January 1 2013
to current. Includes
all parts shown and
security screws.
Part No. 9HACL505A
Chrome Plated

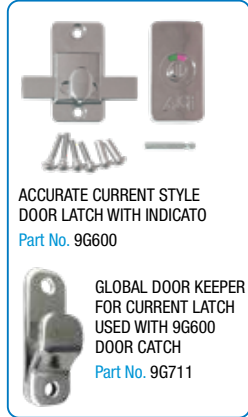

ACCURATE CURRENT STYLE
DOOR LATCH WITH INDICATO
Part No. 9G600

GLOBAL DOOR KEEPER
FOR CURRENT LATCH
USED WITH 9G600
DOOR CATCH
Part No. 9G711



ACCURATE DOOR KIT **OLD STYLE**
Used January 1 2013 to current. Includes
all parts shown and security screws.
Part No. 9HACL505 Chrome Plated



GLOBAL COMPLETE
HINGE SET WITH
ROUNDED EDGE
Part No. 9G663140



ACCURATE PLASTIC
LAMINATE DOOR KIT,
1.25 PILASTER-1
INCH DOOR
Part No. 9A63160

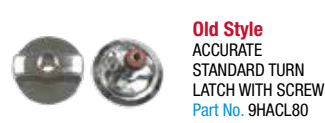

Old Style
ACCURATE
STANDARD TURN
LATCH WITH SCREW
Part No. 9HACL80



 **Old Style**
ACCURATE ADA TURN
LATCH WITH SCREW
Part No. 9HACL85

For use on Plastic Laminate



Old Style
KEEPER BUMPER
For Outswing
For 1-1/4" Sq. Post
Part No. 9HAP23



Old Style
KEEPER BUMPER
For Inswing
For 1-1/4" Sq. Post
Part No. 9HAP27



"U" TRIM
DOOR INSERT
Part No.
9HAP15

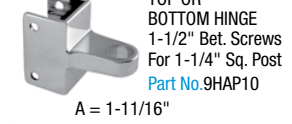

TOP OR
BOTTOM HINGE
1-1/2" Bet. Screws
For 1-1/4" Sq. Post
Part No. 9HAP10
A = 1-11/16"



CAM SET (Plastic)
Part No. 9HAP35



HINGE PIN
3/8" Dia.
3-7/16" Long
Part No. 9HAP30

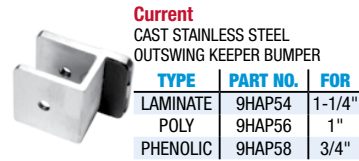

Current
CAST STAINLESS STEEL
OUTSWING KEEPER BUMPER

TYPE	PART NO.	FOR
LAMINATE	9HAP54	1-1/4"
POLY	9HAP56	1"
PHENOLIC	9HAP58	3/4"



Old Style
SLIDE BOLT LATCH
(Surface) 3-1/2"
Bet. Screws
Part No. 9HAP20

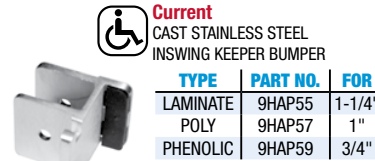

 **Current**
CAST STAINLESS STEEL
INSWING KEEPER BUMPER

TYPE	PART NO.	FOR
LAMINATE	9HAP55	1-1/4"
POLY	9HAP57	1"
PHENOLIC	9HAP59	3/4"

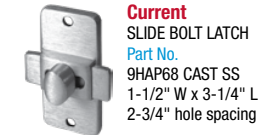

Current
SLIDE BOLT LATCH
Part No.
9HAP68 CAST SS
1-1/2" W x 3-1/4" L
2-3/4" hole spacing



KEEPER BUMPER
For Inswing
For 1-1/4" Sq. Edge
Part No.
9A2353 CHROME



KEEPER BUMPER
For Outswing
For 1-1/4" Sq. Edge
Part No.
9A2354 CHROME



SLIDE BOLT LATCH
Part No. 9A2899
1-1/2" W x 3-1/4" L
2-3/4" bet. Screws



SLIDE LATCH
Part No. 9A6983 CAST SS
1-3/4" W x 1-1/2" L
hole spacing

All American – Chrome Plated Hardware

For use on Metal

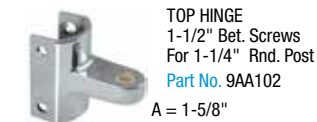

TOP HINGE
1-1/2" Bet. Screws
For 1-1/4" Rnd. Post
Part No. 9AA102
A = 1-5/8"



BOTTOM HINGE
1-1/2" Bet. Screws
For 1-1/4" Rnd. Post
Part No. 9AA103
A = 1-5/8"

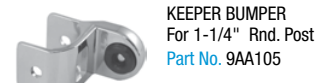

KEEPER BUMPER
For 1-1/4" Rnd. Post
Part No. 9AA105



HINGE PIN
5/16" Dia.
2-13/16" Long
Part No. 9AA101



LATCH COVER & KNOB
Part No. 9AA104C



 LATCH COVER & KNOB
Part No. 9AA104A

For Use On Both Metal & Plastic



PINTLE
1/2" Dia.
Part No.
9AA108



NYLON CAM
Part No.
9AA107

For use on Plastic Laminate



TOP HINGE
1-1/2" Bet. Screws
For 1-1/4" Sq. Post
Part No. 9AA112



BOTTOM HINGE
1-1/2" Bet. Screws
For 1-1/4" Sq. Post
Part No. 9AA113



KEEPER BUMPER
For Inswing
For 1-1/4" Sq. Post
Part No. 9AA115



TOP HINGE
1" Door Insert
Part No. 9AA132

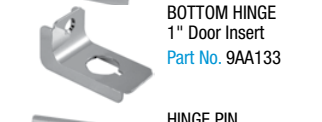

BOTTOM HINGE
1" Door Insert
Part No. 9AA133



HINGE PIN
3/8" Dia.
3-7/16" Long
Part No. 9AA111



**Brackets on
page 63-64**

NEXT DAY DELIVERY AVAILABLE

TOILET PARTITION HARDWARE

Toilet Partition Hardware

AMPCO

For use on Metal

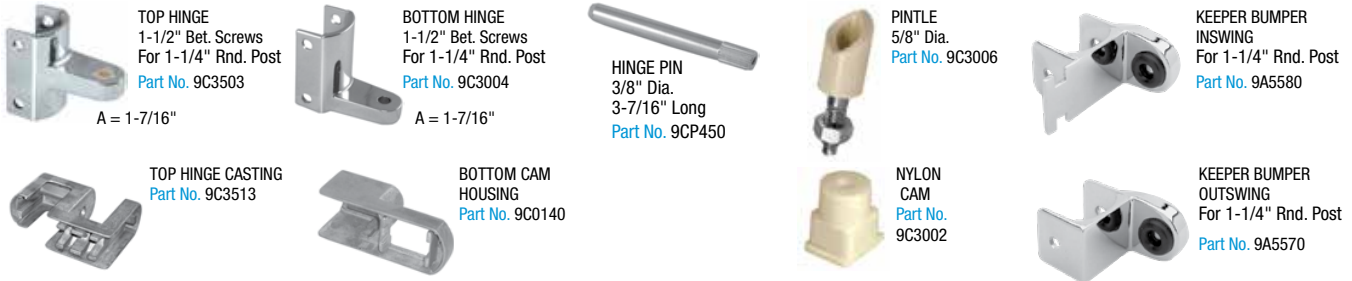

For use on Plastic Laminate



For use on Metal and Plastic Laminate



American Sanitary

Metal Only



Laminate Only

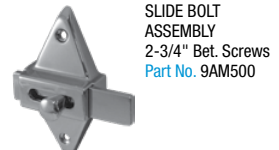
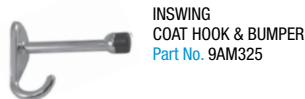













Bobrick Available

NEXT DAY DELIVERY AVAILABLE



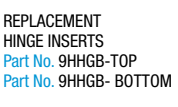













TOILET PARTITION HARDWARE

Toilet Partition Hardware

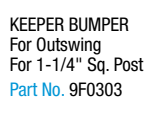
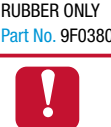
Comtec / Capital / Hiny Hiders













 STRIKE/KEEPER INSWING ALUMINUM 6" High Part No. 9HSISA	 STRIKE/KEEPER OUTSWING ALUMINUM 6" High Part No. 9HSOSA	 COMTEC OUTSWING FLAT STOP 6" High Part No. 9A5898	 COMTEC INSWING FLAT STOP 6" High Part No. 9A5798	 HINGE SET SET OF 2 HINGES 8" High. Instructions Included Part No. 9HHGB	 ADA HINGE SET SET OF 3 HINGES 8" High. Instructions Included Part No. 9HHGBADA	 INTEGRAL HINGE PIN KIT Long pin is 6" x 1/2" dia, Smaller one is 3-1/2" x 1/2" dia Part No. 9INTKIT	 REPLACEMENT INTERGRAL HINGE SET Part No. 9A7005
 TOP REPLACEMENT HINGE INSERTS Part No. 9HHGB-TOP	 BOTTOM REPLACEMENT HINGE INSERTS Part No. 9HHGB- BOTTOM	 TOP COMTEC REPLACEMENT HINGE INSERTS Part No. 9HHINSERT ST	 BOTTOM	 Replacement Hinge inserts USE WITH OUR HINGES ONLY		 SLIDE LATCH ALUMINUM 3-1/2" between screws Part No. 9HLSLA	

Fiat - Chrome Plated Hardware

 TOP HINGE 1-1/2" Bet. Screws For 1-1/4" Sq. Post For 7/16" dia. Pin Part No. 9F0211N	 BOTTOM HINGE 1-1/2" Bet. Screws For 1-1/4" Sq. Post Part No. 9F0301 Chrome Part No. 9A3293 Cast SS A = 1-5/8"	 TOP HINGE 1-1/2" Bet. Screws For 1-1/4" Sq. Post Part No. 9F0300 Chrome Part No. 9A3793 Cast SS A = 1-11/16"	 BOTTOM HINGE For 1-1/4" Sq. Post Part No. 9F0214N A = 1-11/16"
 TOP HINGE DOOR ESCUTCHEON For 1" Thick Doors Part No. 9F0316	 BOTTOM HINGE DOOR INSERT For 1" Thick Doors Part No. 9F0317	 SLIDE BOLT ASSEMBLY 2-3/4" Bet. Screws 9/16" Bar to Door Clearance Part No. 9F0302	 (New) Part No. 92500B  INCLUDES PIN When Ordering Specify Pin Type  Straight or Offset
 TOP PIN (Metal) 3/8" Dia. 3-7/16" Long Part No. 9F0310	 KEEPER BUMPER For Outswing For 1-1/4" Sq. Post Part No. 9F0303	 RUBBER ONLY Part No. 9F0380	
 TOP PIN (Metal) 7/16" Dia. 3-3/16" Long Part No. 9F0207N	 KEEPER BUMPER Part No. 9F0227	 NYLON CAM Part No. 9F0312	 PINTLE 11/16" Dia. Part No. 9F0311
 Brackets on page 63-64			

Flush Metal

For use on Metal

 TOP HINGE 1-1/2" Bet. Screws For 1-1/4" Rnd. Post Part No. 9FL100 A = 1-7/16"	 BOTTOM HINGE 1-1/2" Bet. Screws For 1-1/4" Rnd. Post Part No. 9FL200 A = 1-7/16"	 BOTTOM CAM HOUSING FRONT Part No. 9FL275 Unplated Part No. 9FL275CH Chrome plated	 TOP HINGE CASTING For use on metal. Part No. 9FL265
 KEEPER BUMPER For 1-1/4" Rnd. Post Part No. 9FL400	 COAT HOOK & BUMPER Part No. 9FL450	 NYLON CAM Part No. 9FL225	 PINTLE 5/8" Dia. Part No. 9FL250
 TOP PIN 3/8" Dia., 3" Long Part No. 9FL125	 LATCH KNOB & COVER (Concealed) Part No. 9FL325	 KNOB & COVER Part No. 9FL325A	 LATCH HOUSING FOR CONCEALED LATCH (Unplated) Part No. 9A6606











NEXT DAY DELIVERY AVAILABLE

TOILET PARTITION HARDWARE

Toilet Partition Hardware

FLUSH METAL (Continued)

For use on Plastic Laminate

 <p>TOP HINGE 1-1/2" Bet. Screws For 1-1/4" Sq. Post Part No. 9FL600 Chrome Part No. 9A3793 Cast SS A = 1-5/8"</p>	 <p>BOTTOM HINGE 1-1/2" Bet. Screws For 1-1/4" Sq. Post Part No. 9FL700 Chrome Part No. 9A3293 Cast SS A = 1-5/8"</p>	 <p>TOP HINGE DOOR ESCUTCHEON For 7/8" Thick Doors Part No. 9FL650</p>	 <p>BOTTOM HINGE DOOR INSERT Part No. 9FL775</p>	 <p>TOP PIN (Metal) 3/8" Dia. 3-1/2" Long Part No. 9FL625</p>
 <p>KEEPER BUMPER For Outswing For 1-1/4" Sq. Post Part No. 9FL900</p>	 <p>KEEPER BUMPER For Inswing For 1-1/4" Sq. Post Part No. 9FL925</p>	 <p>SLIDE BOLT ASSEMBLY 2-3/4" Bet. Screws Part No. 9FL800</p>	 <p>NYLON CAM Part No. 9FL725</p>	 <p>PINTLE 15/32" Dia. Part No. 9FL750</p>















GENERAL

For use on Plastic Laminate







 <p>TOP HINGE 1-1/2" Bet. Screws For 1-1/4" Sq. Post Part No. 91500P Chrome Part No. 9A3793 Cast SS A = 1-11/16"</p>	 <p>BOTTOM HINGE 1-1/2" Bet. Screws For 1-1/4" Sq. Post Part No. 91000P Chrome Part No. 9A3293 Cast SS A = 1-11/16"</p>	 <p>SLIDE BOLT LATCH 2-3/4" Bet. Screws 9/16" Bar to Door Clearance Part No. 92000P</p>	 <p>KEEPER BUMPER For Inswing For 1-1/4" Sq. Post Part No. 920601</p>	 <p>KEEPER BUMPER For Outswing For 1-1/4" Sq. Post Part No. 92060E</p>
--	---	---	--	--

For Use on Metal

Older Style

 <p>TOP HINGE 1-1/2" Bet. Screws For 1-1/4" Rnd. Post Part No. 91500B</p>	 <p>BOTTOM HINGE 1-1/2" Bet. Screws For 1-1/4" Rnd. Post Part No. 91000B A = 1-5/8"</p>	 <p>KEEPER BUMPER For Inswing and Outswing For 1-1/4" Sq. Post Part No. 92560E</p>
 <p>KEEPER BUMPER For 1-1/4" Rnd. Post Part No. 92060B</p>	 <p>BOTTOM CAM HOUSING Part No. 91005B Unplated Part No. 91005BC Chrome Plated</p>	 <p>TOP PIN (Metal) 3/8" Dia. 3-3/4" Long Part No. 91504B</p>
 <p>PINTLE 11/16" Dia. Part No. 91006B</p>	 <p>LATCH KNOB & COVER (Concealed 2 pin style) Part No. 92500A</p>	 <p>TOP PIN 3/8" Dia. 3" Long For 91500B & 91500P Part No. 91503B</p>
 <p>NYLON CAM Part No. 91002B</p>	<div style="border: 1px solid black; padding: 5px;"> <p>(New) Part No. 92500B INCLUDES PIN When Ordering Specify Pin Type</p> <p>Straight or Offset</p> </div>	 <p>BUMPER KEEPER For 1-1/4" Rnd. Post Part No. 9K0152</p>
 <p>TOP HINGE CASTING For Metal Doors Part No. 9K0245</p>	 <p>LATCH KNOB & COVER (Concealed) Part No. 92000C</p>	 <p>LATCH KNOB Part No. 92500C w/straight pin Part No. 9A8190 w/offset pin</p>

Newer Style

 <p>TOP HINGE 1-1/8" Bet. Screws For 1-1/4" Rnd. Post Part No. 96320A A = 1-11/16"</p>	 <p>BOTTOM HINGE 1-1/8" Bet. Screws For 1-1/4" Rnd. Post Part No. 96319A A = 1-11/16"</p>	 <p>N/A BOTTOM CAM & PINTLE Part No. 96319E</p>
 <p>LATCH KNOB (Concealed) Part No. 96318A Chrome Part No. 9HH101 Cast SS</p>	 <p>LATCH COVER (Concealed) Part No. 96318B Chrome Part No. 9HH201 Cast SS</p>	 <p>TOP PIN 1/4" Dia. 2-7/8" Long Part No. 96320B</p>
 <p>LATCH KNOB (Concealed) Part No. 96318AA Chrome Part No. 9HH111 Cast SS</p>		

NEXT DAY DELIVERY AVAILABLE

TOILET PARTITION HARDWARE

Toilet Partition Hardware

GLOBAL - Chrome Plated Hardware



TOP HINGE
1-1/2" Bet. Screws
For 1-1/4" Rnd. Post
Part No. 9G0225



BOTTOM HINGE
1-1/2" Bet. Screws
For 1-1/4" Rnd. Post
Part No. 9G0230

A = 1-7/16"



TOP HINGE CASTING
Part No. 9G0220



BOTTOM CAM HOUSING
Part No. 9FL275CH -
Chrome Plated



PINTLE
5/8"
Part No. 9G0237



NYLON CAM
Part No. 9G0232



PIN
3/8" Dia. x 3" Long
Part No. 9G2252



TOP PIN (Metal)
3/8" Dia. x 3-3/4" Long
Part No. 9G2253

For use on Metal



KEEPER BUMPER
For Outswing
For 1-1/4" Rnd. Post
Part No. 9G015E



KEEPER BUMPER
For Inswing
For 1-1/4" Rnd. Post
Part No. 9G0151



SLIDE BOLT LATCH
(Surface) 3-1/2" Bet. Screws
5/8" Bar to Door Clearance
Part No. 9G0136



SLIDE BOLT LATCH
With 3/8" Door to
Offset Bar Clearance
Part No. 9G0137



KEEPER BUMPER
For 1-1/4" Rnd. Post
Part No. 9G150C



BOTTOM CAM HOUSING
Part No. 9FL275CH -
Chrome Plated



GLOBAL OUT SWING DOOR KIT
Part No. 9A85-13514



GLOBAL COMPLETE HINGE SET WITH ROUNDED EDGE
Part No. 9G663140



ADA DOOR KIT
Part No. 9G4000A Chrome Plated



GLOBAL PLASTIC LAMINATE DOOR KIT, 1.25 PILASTER-1 INCH DOOR
Part No. 9A63160



LATCH KNOB & COVER (Concealed)
Part No. 9G0139 - Chrome Plated
Part No. 9A6148 - Cast SS



LATCH KNOB & COVER
Part No. 9G0139A - Chrome Plated
Part No. 9A6158 - Cast SS



LATCH KNOB & COVER (Screw fastened)
Part No. 9G0139AS
(Old Style)



LATCH KNOB & COVER (Screw Fastened/Concealed)
Part No. 9G0139S
(Old Style)



Current
GLOBAL POWDER COATED STEEL IN SWING DOOR KIT
Part No. 9A85-13513



COMPLETE STANDARD DOOR KIT. INCLDS. SAFETY SCREWS
Part No. 9G4000 Chrome Plated



Current
GLOBAL STYLE DOOR LATCH WITH INDICATOR
Part No. 9G600



GLOBAL DOOR KEEPER FOR CURRENT LATCH USED WITH 9G600 DOOR CATCH
Part No. 9G711

For use on Plastic Laminate



TOP OR BOTTOM HINGE
1-1/2" Bet. Screws
For 1-1/4" Sq. Post
Part No. 9G631A



KEEPER BUMPER
For Inswing and Outswing
For 1-1/4" Sq. Post
Part No. 9G631H



"U" TRIM DOOR INSERT
Part No. 9G631B



HINGE PIN (Metal)
3/8" Dia. x 3-7/16" Long
Part No. 9G631C



CAM SET (Plastic)
Part No. 9G631E



(New)
LATCH COVER & KNOB
Part No. 9G631F

INCLUDES PIN
When Ordering
Specify Pin Type















Straight or Offset

NEXT DAY DELIVERY AVAILABLE

TOILET PARTITION HARDWARE



Toilet Partition Hardware

HADRIAN - Chrome Plated Hardware

 <p>WRAP AROUND TOP HINGE For 1-1/4" Rnd. Post Part No. 9HH350 Chrome 9HH360 Cast SS</p>	 <p>TOP HINGE Part No. 9HH300</p>	 <p>BOTTOM HINGE Part No. 9HH500</p>	 <p>WRAP AROUND BOTTOM HINGE For 1-1/4" Rnd. Post Part No. 9HH550 Chrome 9HH560 Cast SS</p>	 <p>KEEPER BUMPER For 1-1/4" Rnd. Post Part No. 9HH800 Chrome 9HH810 Cast SS</p>
 <p>UPPER DOOR CASTING Part No. 9HH325 Unplated Part No. 9HH326 Cast SS</p>	 <p>SLIDE BOLT LATCH 2-3/4" Bet. Screws Part No. 9HH125 Chrome 9F0302SS Cast SS</p>	 <p>NYLON CAM Part No. 9HH700</p>	 <p>TOGGLE & SCREW For Hinges Part No. 9HH450</p>	 <p>TOP PIN Part No. 9HH400</p>
 <p>LOWER DOOR CASTING Part No. 9HH525 Unplated Part No. 9HH526 Cast SS</p>	 <p>TURN LATCH & COVER Part No. 9A601150 Chrome</p>	 <p>TURN LATCH & COVER Part No. 9A901150 SS</p>	 <p>PINTLE 1/2" Dia. Part No. 9HH600</p>	

Knickerbocker - Chrome Plated Hardware

For use on Metal

 <p>TOP HINGE 1-1/8" Bet. Screws For 1-1/4" Rnd. Post Part No. 9K0240 A = 1-11/16"</p>	 <p>BOTTOM HINGE 1-1/8" Bet. Screws For 1-1/4" Rnd. Post For 9KCAMM & 9K0231 Part No. 9K0230 A = 1-11/16"</p>	 <p>BOTTOM CAM Part No. 9KCAMM</p>	 <p>TOP PIN (PLASTIC) 1/4" Dia. x 2-3/4" Long Part No. 9K241M</p>
 <p>BOTTOM CAM HOUSING Part No. 9K0340 Not Plated</p>	 <p>TOP HINGE CASTING For Metal Doors Part No. 9K0245</p>	 <p>BOTTOM CAM & PINTLE Part No. 9K0231N</p>	<p>N/A</p>

For use on Plastic Laminate

 <p>TOP HINGE 1-1/2" Bet. Screws For 1-1/4" Sq. Post Part No. 9K1240 A = 1-11/16"</p>	 <p>BOTTOM HINGE 1-1/2" Bet. Screws For 1-1/4" Sq. Post Part No. 9K1230 A = 1-11/16"</p>	 <p>BOTTOM HOUSING Part No. 9K1340</p>
 <p>TOP PIN 1/4" Dia. X 2-7/8" Long Part No. 9K241P</p>	 <p>BOTTOM CAM Part No. 9KCAMP</p>	 <p>DOOR LATCH INSIDE MECHANISM-KIT Part No. 9K0253</p>

For use on Plastic Laminate and Metal

 <p>LATCH KNOB (Concealed) Part No. 9K0250</p>	 <p>LATCH COVER (Concealed) Part No. 9K0255</p>	 <p>LATCH KNOB & COVER (Concealed) Part No. 9K0250A</p>	 <p>PINTLE 5/8" Dia. Part No. 9K0231</p>
---	--	--	---

NEXT DAY DELIVERY AVAILABLE

TOILET PARTITION HARDWARE

Toilet Partition Hardware

METPAR

For use on Plastic Laminate and Metal



TOP HINGE
1-1/2" Bet. Screws
For 1-1/4" Sq. Post
Part No. 9CP400
A = 1-9/16"



BOTTOM HINGE
1-1/2" Bet. Screws
For 1-1/4" Sq. Post
Part No. 9CP300
A = 1-9/16"



TOP HINGE DOOR ESCUTCHEON
For 7/8" Thick Doors
Part No. 9CP425



BOTTOM HINGE DOOR INSERT
Part No. 9CP325



KEEPER BUMPER
For Outswing
For 1-1/4" Sq. Post
Part No. 9CP200



KEEPER BUMPER
For Inswing
For 1-1/4" Sq. Post
Part No. 9CP250



SLIDE BOLT LATCH
2-3/4" Bet. Screws
Part No. 9CP100



TOP PIN (Metal)
3/8" Dia.
3-1/2" Long
Part No. 9CP450



NYLON CAM
Part No. 9CP375



PINTLE
1/2" Dia.
Part No. 9CP350



For use on Metal



TOP HINGE
1-1/2" Bet. Screws
For 1-1/4" Rnd. Post
Part No. 9C3503
A = 1-7/16"



BOTTOM HINGE
1-1/2" Bet. Screws
For 1-1/4" Rnd. Post
Part No. 9C3004
A = 1-7/16"



BOTTOM CAM HOUSING
Part No. 9C0140 Unplated
Part No. 91005 BC Chrome PLated



TOP HINGE CASTING
Part No. 9C3513



KEEPER BUMPER
For 1-1/4" Rnd. Post
Part No. 90C410



LATCH COVER & KNOB (Concealed)
Part No. 90C300



 **LATCH COVER & KNOB**
Part No. 90C300A



SLIDE BOLT LATCH
Part No. 90C400



NYLON CAM
Part No. 9C3002



PINTLE
5/8" Dia.
Part No. 9C3006



NYLON CAM
Pintle Combination
Part No. 9C0235



TOP PIN (Metal)
3/8" Dia.
3-3/4" Long
Part No. 9C3505



TOP PIN (Metal)
3/8" Dia.
3" Long
Part No. 9C3504



If in Doubt Please Send a Sample

MILLS - Chrome Plated Hardware



KEEPER BUMPER (Porc.)
Part No. 90T317



TOP & BOTTOM HINGE
1-3/8" Bet. Screws
Part No. 90T100-110



KEEPER BUMPER
Part No. 90T116



BUMPER KEEPER
Part No. 90T120



SLIDE BOLT/LATCH
2-3/4" Bet. Screws
3/8" Bars to Door Clearance
Part No. 90T160



LATCH / KEEPER BUMPER KIT
Part No. 90T390



SLIDE BOLT/LATCH (Concealed)
Part No. 90T290



COAT HOOK & BUMPER
3-3/8" Projection
2-3/4" High
Part No. 90T285



KEEPER BUMPER (18 GA.)
1-5/8" Bet. Screws
Part No. 90T316

NEXT DAY DELIVERY AVAILABLE

TOILET PARTITION HARDWARE

Toilet Partition Hardware

Sanymetal – Chrome Plated Hardware

For use on Metal



N/A TOP HINGE
1-1/4" Bet. Screws
For 1-1/4" Rnd. Post
Part No. 9S7780
A = 1-9/16"



BOTTOM HINGE
1-1/4" Bet. Screws
For 1-1/4" Rnd. Post
Part No. 9S7770
A = 1-9/16"



Keeper Bumper
For 1-1/4" Rnd. Post
Part No. 9S8801



BUMPER
For Latch
2" Bet. Screws
Part No. 9S2400



STOP
1-1/2" Bet. Screws
Part No. 9S2704



KEEPER BUMPER
For Inswing
For 1-1/4" Sq. Post
Part No. 9S410T



KEEPER
For Latch
2" Bet. Screws
Part No. 9S2401



SLIDE BOLT/LATCH
2-5/8" Bet. Screws
Part No. 9S7431



KEEPER
1-1/2" Bet. Screws
Part No. 9S2701



THROW LATCH
3-1/2" Bet. Screws
Part No. 9S7531



POST TOGGLE & SCREW
Part No. 9S5860

LATCH KNOB, COVER & PIN KIT PART NO. 9S8819



Latch Knob



Latch Cover



Latch Pin



PLASTIC PIN
For 7361, 5861 & 7780
3/8" Dia.
2-1/2" Long
Part No. 9S7774



BOTTOM POWER BEARING
(Concealed)
For 9S5862 & 9S7770
Part No. 9S7961

LATCH KNOB & COVER PART NO. 9S8820



Notched



Brackets on page 63-64



For use on Plastic Laminate and Metal



TOP HINGE
1-1/4" Bet. Screws
For 1-1/4" Sq. Post
Part No. 9S7361
A = 1-1/2"



BOTTOM HINGE
1-1/4" Bet. Screws
For 1-1/4" Sq. Post
Part No. 9S7360
A = 1-1/2"



KEEPER BUMPER
For 1-1/4" Sq. Post
Part No. 9S8861

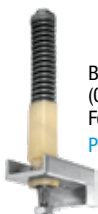

BOTTOM POWER BEARING
(Concealed)
For 9S7360
Part No. 9S6100



COAT HOOK & BUMPER
1-1/8" bet. Screws
Part No. 9S7810



TOP DOOR HINGE
ESCTCHEON
Part No. 9S6101



COAT HOOK & BUMPER
7/8" bet. Screws
Part No. 9S6810B

NEXT DAY DELIVERY AVAILABLE

TOILET PARTITION HARDWARE

Common Toilet Partition Hardware



ADA* Latches for use with lift type keeps



Fasteners Included – Chrome Plated Zamac Unless Indicated



SLIDE BOLT ASSEMBLY
2-3/4" Bet. Screws
9/16" Bar to Door Clearance
Part No. 9F0302 - Chrome
Part No. 9F0302SS - Cast Stainless Steel



SLIDE BOLT LATCH
2-3/4" Between Screws
3/8" Bar to Door Clearance
Part No. 90T160 - Chrome
Part No. 9A5033 - Cast Stainless Steel



SLIDE BOLT LATCH
3-1/2" Between Screws
5/8" Bar to Door Clearance
Part No. 9G0136 - Chrome
Part No. 9A5053 - Cast Stainless Steel



SLIDE BOLT LATCH
3-1/2" Between Screws
3/8" Door to offset bar clearance
Part No. 9G0137 - Chrome
Part No. 9A5063 - Cast Stainless Steel



SLIDE BOLT LATCH
2-5/8" Bet. Screws
Part No. 9S7431



STAINLESS STEEL
1-7/8" Between Screws
1/8" Bar to Door Clearance
Part No. 9A7055
* See Stainless Steel section for Keeper/stop



SLIDE BOLT LATCH
Aluminum 3-1/2" Between Screws
Part No. 9HLSLA



SLIDE BOLT LATCH
Aluminum 3-1/2" Between Screws
Part No. 9A0102



SLIDE BOLT LATCH
1-1/2" W x 3-1/4" L
2-3/4" bet. Screws
Part No. 9A2899
Chrome Plated



SLIDE LATCH
1-3/4" W x 1-1/2" L
hole spacing
Part No. 9A6983 CAST SS



BOBRICK SLIDE LATCH
Part No. 9A0102



EUROPEAN STYLE LATCH
Part No. 901CS-



SLIDE BOLT LATCH
Part No. 9HAP68 CAST SS
1-1/2" W x 3-1/4" L
2-3/4" hole spacing



THROW LATCH
Chrome Plated Brass
3-1/2" Bet. Screws
Part No. 9S7531



INSWING LATCH & STRIKE
Stamped Stainless Steel
Can be used for outswing if door and post are equal.
Part No. 9A0104



HEAVY DUTY THROW LATCH WITH KEEPER
Chrome Plated Brass
Part No. 9S5701



LATCH & KEEPER
Stamped Stainless Steel
Part No. 9A0106



LATCH WITH KEEPER
Indicator an Door Pull
Part No. 9A6069



SLIDE LATCH WITH INDICATOR
Part No. 9A1245 - SS



CURRENT STYLE GLOBAL SLIDE LATCH WITH INDICATOR
Part No. 9G600



CURRENT STYLE GLOBAL SLIDE LATCH WITH INDICATOR
Part No. 9G700 - SS



CURRENT STYLE BRUSHED ALUMINUM SLIDE LATCH
Part No. 9G900



CONCEALED LATCH KIT
Part No. 9A6629



CONCEALED LATCH KIT
Part No. 9A6629



CONCEALED LATCH FIX IT KITS

- To cover up Concealed Latch Holes
- For Powder Coated Steel & Plastic Laminate Doors
 - For 1" Thick Doors - Round Edge for Powder Coated
 - Steel and for 1" Square edge for Plastic Laminate
 - For 1-1/4" Pilasters
 - All Hardware included
 - SlideBolt Latch
 - Inswing or Outswing Hardware(Keeper Bumper)
 - Stainless Steel "U" Shape cover for both sides of door
 - All Screws Included

Chrome Plated Zamac

PART NO.	EDGE TYPE & DOOR SWING
9A1116	Round Edge Inswing
9A1117	Round Edge Outswing
9A1118	Square Edge Inswing
9A1119	Square Edge Outswing

Stainless Steel

PART NO.	EDGE TYPE & DOOR SWING
9A1122	Round Edge Inswing
9A1123	Round Edge Outswing
9A1120	Square Edge Inswing
9A1121	Square Edge Outswing



*** PLEASE CHECK WITH YOUR LOCAL CODE TO VERIFY ADA REQUIREMENTS.**

NEXT DAY DELIVERY AVAILABLE

TOILET PARTITION HARDWARE

Common Toilet Partition Hardware



ADA* Latches for use with lift type keeps



Fasteners Included – Chrome Plated Zamac Unless Indicated

Door Handles – Chrome Plated



DOOR PULL
3-1/2" Bet. Screws
Part No. 9A0540 - Chrome Plated
Part No. 9A5403 - Cast SS

DOOR PULL
4" Bet. Centers
Part No. 9A0171

DOOR PULL
2-3/4" Bet. Centers
Part No. 9A0620 - Chrome
Part No. 9A6203 - Cast SS

DOUBLE DOOR PULL
6" Bet. Centers for 1" doors
Part No. 9HH001 - Chrome Plated
Part No. 9HH910 - Cast SS

DOUBLE DOOR PULL
4" Bet. Centers
Part No. 9A4400 - Chrome Plated
Part No. 9A4403 - Cast SS

ADA* Door Pull



ADA DOOR PULL
3" High x 5-1/8" Long
Part No. 9A0625 - Cast SS



*** PLEASE CHECK WITH YOUR LOCAL CODE TO VERIFY ADA REQUIREMENTS.**

Coat Hooks and Door Stops

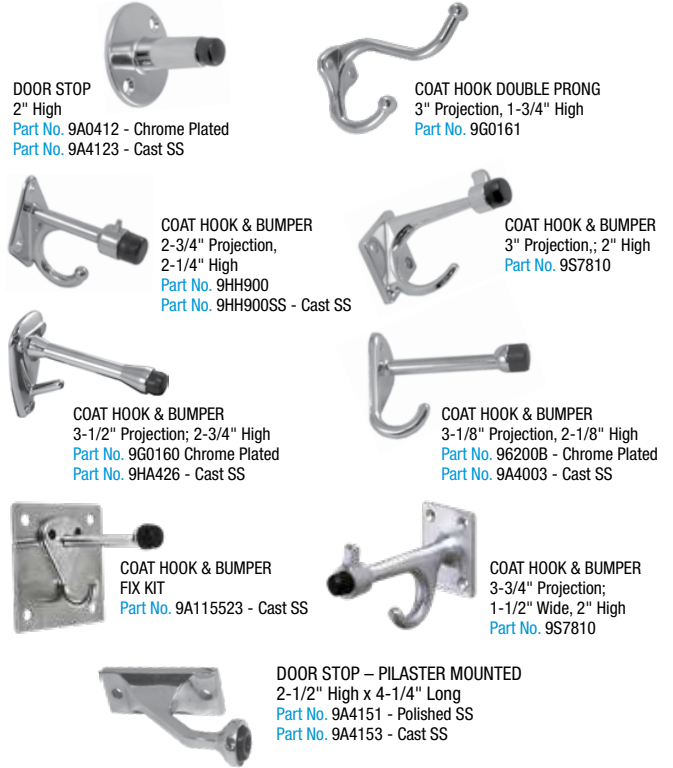

DOOR STOP
2" High
Part No. 9A0412 - Chrome Plated
Part No. 9A4123 - Cast SS

COAT HOOK DOUBLE PRONG
3" Projection, 1-3/4" High
Part No. 9G0161

COAT HOOK & BUMPER
2-3/4" Projection,
2-1/4" High
Part No. 9HH900
Part No. 9HH900SS - Cast SS

COAT HOOK & BUMPER
3" Projection, 2" High
Part No. 9S7810

COAT HOOK & BUMPER
3-1/2" Projection; 2-3/4" High
Part No. 9G0160 Chrome Plated
Part No. 9HA426 - Cast SS

COAT HOOK & BUMPER
3-1/8" Projection, 2-1/8" High
Part No. 96200B - Chrome Plated
Part No. 9A4003 - Cast SS

COAT HOOK & BUMPER
FIX KIT
Part No. 9A115523 - Cast SS

COAT HOOK & BUMPER
3-3/4" Projection;
1-1/2" Wide, 2" High
Part No. 9S7810

DOOR STOP – PILASTER MOUNTED
2-1/2" High x 4-1/4" Long
Part No. 9A4151 - Polished SS
Part No. 9A4153 - Cast SS

Square Edged Wrap Around Hinge Sets

Fasteners Included, Chrome Plated Zamac Unless Indicated

7/8" Thick Doors 1-1/4" Thick Pilasters

1" Thick Doors 1" Thick Pilasters

1" Thick Doors 1-1/4" Thick Pilasters

Hinge Set

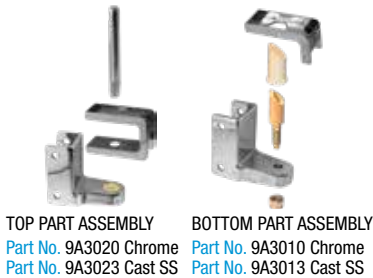

TOP PART ASSEMBLY
Part No. 9A3020 Chrome
Part No. 9A3023 Cast SS

BOTTOM PART ASSEMBLY
Part No. 9A3010 Chrome
Part No. 9A3013 Cast SS



TOP & BOTTOM PART ASSEMBLY
Part No. 9A3780 Chrome
Part No. 9A3153 Cast SS

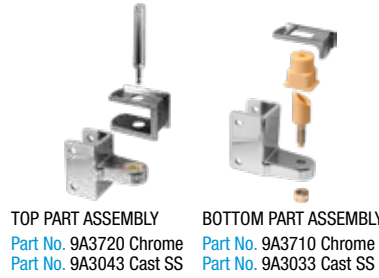

TOP PART ASSEMBLY
Part No. 9A3720 Chrome
Part No. 9A3043 Cast SS

BOTTOM PART ASSEMBLY
Part No. 9A3710 Chrome
Part No. 9A3033 Cast SS

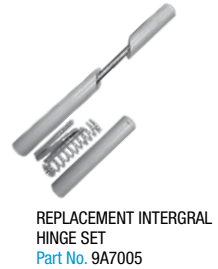

REPLACEMENT INTEGRAL HINGE SET
Part No. 9A7005



TOP & BOTTOM PART ASSEMBLY
1 inch door - 1 inch post
Part No. 9A3780



TOP & BOTTOM PART ASSEMBLY
1 inch door - 1.25 inch post
Part No. 9A3130 Chrome Plated
Part No. 9A3153 Cast SS

NEXT DAY DELIVERY AVAILABLE

TOILET PARTITION HARDWARE

Common Toilet Partition Hardware

ADA Continuous Piano and Full Length Surface Mounted Hinges

Can be Raised up 3/8" for Emergency Entry

- Strengthen your Door • Provide More Privacy • Made of Stamped Stainless Steel •



16 Gauge - 1/8" Pin
54" & 57-1/2" lengths
with Spring Close

PART NO.	DOOR SWING	LENGTH
9A70C1	RH-OUT, LH-IN	57-1/2"
9A70C2	LH-OUT, RH-IN	57-1/2"
9A70C4	RH-OUT, LH-IN	54"
9A70C5	LH-OUT, RH-IN	54"

Without Spring Close

PART NO.	DOOR SWING	LENGTH
9A70C3	ALL	57-1/2"



Anodized Aluminum
1/4" Pin - 54" length
with Spring Close

PART NO.	DOOR SWING	LENGTH
9A8674	RH-IN LH-OUT	54"
9A8684	LH-IN, RH-OUT	54"

16 Gauge - 1/8" Pin
71-1/2" length
with Spring Close

PART NO.	DOOR SWING	LENGTH
9A7759	RH-IN LH-OUT	71-1/2"
9A7769	LH-IN, RH-OUT	71-1/2"



14 Gauge - 1/4" Pin
57" length with Spring Close

PART NO.	DOOR SWING	LENGTH
9A7339	LH-OUT, RH-IN	57"
9A7349	RH-OUT, LH-IN	57"



14 Gauge - 1/4" Pin
57" length
20° Degree Cam Close

PART NO.	DOOR SWING	LENGTH
9A9401	20° CAM CLOSE	57"



Vault Hinge



VAULT HINGE SET
HEAVY DUTY CAST STAINLESS STEEL
Part No. 9A7813 Use for 3/4" to 1" door

Surface Mounted Hinge Sets (Upper and Lower)

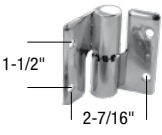
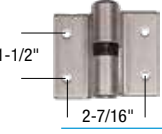
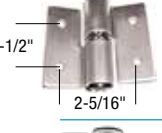
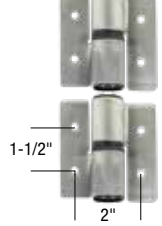
Medium Duty

	MATERIAL	ROUND BARREL DOOR SWING	PART NO.
	CHROME PLATED BRASS	FOR RIGHT HAND OUTSWING OR LEFT HAND INSWING	9A70B1
		FOR LEFT HAND OUTSWING OR RIGHT HAND INSWING	9A70B2
	STAMPED STAINLESS STEEL	FOR RIGHT HAND OUTSWING OR LEFT HAND INSWING	9A7043
		FOR LEFT HAND OUTSWING OR RIGHT HAND INSWING	9A7033
	STAMPED STAINLESS STEEL	FOR RIGHT HAND OUTSWING OR LEFT HAND INSWING	9A7103
		FOR LEFT HAND OUTSWING OR LEFT HAND INSWING	9A7093
	STAMPED STAINLESS STEEL	SURFACE MOUNT UNIVERSAL HANDING HINGE FOR BOTH RIGHT AND LEFT HAND OUTSWING OR RIGHT AND LEFT HAND INSWING	9A8241
	POLISHED STAINLESS STEEL	SURFACE MOUNT DOOR HINGE SET FOR LEFT HAND OUTSWING OR RIGHT HAND INSWING	9A7070
		SURFACE MOUNT DOOR HINGE SET FOR RIGHT HAND OUTSWING OR LEFT HAND INSWING	9A7083

Heavy Duty

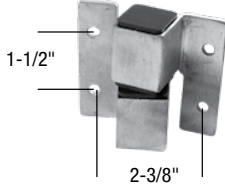
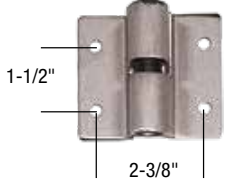
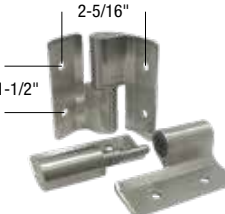
	MATERIAL	SQUARE BARREL DOOR SWING	PART NO.
	STAINLESS STEEL	FOR RIGHT HAND OUTSWING OR LEFT HAND INSWING	9A7051
		FOR LEFT HAND OUTSWING OR RIGHT HAND INSWING	9A7052
	CAST STAINLESS STEEL	FOR RIGHT HAND OUTSWING OR LEFT HAND INSWING	9A7SS1
		FOR LEFT HAND OUTSWING OR RIGHT HAND INSWING	9A7SS2
	CAST STAINLESS STEEL	SURFACE MOUNT FOR RIGHT HAND OUTSWING OR LEFT HAND INSWING	9A7283
		FOR LEFT HAND OUTSWING OR RIGHT HAND INSWING	9A7273

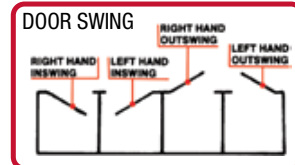

SUPPLIED WITH FASTENERS FOR 1" DOORS & 1-1/4" POST. OTHERS SCREWS AVAILABLE.

NEXT DAY DELIVERY AVAILABLE

TOILET PARTITION HARDWARE

Common Toilet Partition Hardware

Strike and Keepers for Square Edge Posts

Fasteners Included, Chrome Plated Zamac Unless Indicated

NEXT DAY DELIVERY AVAILABLE



KEEPER BUMPER
For Inswing
1-1/2" bet.screws

PART NO.	POST SIZE
CHROME PLATED	
9A5620	1"
9F0304	1-1/4"
CAST STAINLESS STEEL	
9A5623	1"
9A5113	1-1/4"



KEEPER BUMPER
For Outswing
1-1/2" bet.screws

PART NO.	POST SIZE
CHROME PLATED	
9A5720	1"
9F0303	1-1/4"
CAST STAINLESS STEEL	
9A5723	1"
9A5213	1-1/4"



KEEPER BUMPER
For Inswing
1-1/2" bet.screws

PART NO.	POST SIZE
CHROME PLATED	
9A5820	1"
9S410T	1-1/4"
CAST STAINLESS STEEL	
9A4903	3/4"
9A5823	1"
9A5343	1-1/4"



KEEPER BUMPER
For Inswing and Outswing
for Concealed Latch

PART NO.	POST SIZE
CHROME PLATED	
9A5730	1"
92560E	1-1/4"
CAST STAINLESS STEEL	
9A5733	1"
9A5233	1-1/4"



KEEPER BUMPER
For Inswing
1-9/16" bet. screws
Flat surface type
Part No. 90T116 Chrome
Part No. 9A5143 Cast SS



KEEPER BUMPER
For Inswing OR Outswing
1-1/2" bet. screws
Flat surface type
Part No. 9A5240 Chrome
Part No. 9A5243 Cast SS



KEEPER BUMPER
For Outswing
1-1/2" bet. screws
Flat surface type
Part No. 9A5260 Chrome
Part No. 9A5263 Cast SS



KEEPER BUMPER
For Inswing
1-1/2" bet. screws
Flat surface type
Part No. 9A5985 Chrome
Part No. 9A5283 Cast SS



ANY THICKNESS POST
1-7/8" Bet. Screws
Inswing use:
Keeper - Part No. 9A7056
and
Stop - Part No. 9A7057
Outswing ONLY use:
Part No. 9A7057



KEEPER STOP
ANY THICKNESS POST
1-1/2" Bet. Screws
Inswing use:
Keeper -
Part No. 9S2401J Chrome
and
Stop:
Part No. 9S2704 Chrome
Part No. 9A5173 Cast SS
Outswing ONLY use:
Part No. 9S2704 Chrome



KEEPER STOP
ANY THICKNESS POST
1-1/2" Bet. Screws
Inswing use:
Keeper -
Part No. 9S2701 Chrome
Part No. 9A5183 Cast SS
and
Stop:
Part No. 9S2704 Chrome
Part No. 9A5173 Cast SS
Outswing ONLY use:
Part No. 9S2704 Chrome



KEEPER BUMPER
For Outswing
1-1/4" Post
Part No. 9A5970 Chrome
Part No. 9A5973 Cast SS



KEEPER BUMPER
For Inswing
1-1/4" Post
Part No. 9A5980 Chrome
Part No. 9A5983 Cast SS



DOOR KEEPER FOR
CURRENT LATCH
USED WITH 9G600 DOOR
CATCH
Part No. 9G711 Chrome
Part No. 9G755 Cast SS

CAST STAINLESS STEEL OUTSWING KEEPER BUMPER			
TYPE	PART NO.	FOR	
LAMINATE	9HAP54	1-1/4"	
POLY	9HAP56	1"	
PHENOLIC	9HAP58	3/4"	



KEEPER BUMPER
For Outswing
For 1-1/4" Sq. Edge
Part No. 9A2354 CHROME



KEEPER BUMPER
Inswing or Outswing
for Concealed Latch
1-1/4" Post
Part No. 9F0227 Chrome



KEEPER BUMPER
For Outswing
Flat Surface
Part No. 9A5640 Chrome
Part No. 9A5643 Cast SS

CAST STAINLESS STEEL INSWING KEEPER BUMPER			
TYPE	PART NO.	FOR	
LAMINATE	9HAP55	1-1/4"	N/A
POLY	9HAP57	1"	
PHENOLIC	9HAP59	3/4"	



KEEPER BUMPER
For Inswing
For 1-1/4" Sq. Edge
Part No. 9A2353 CHROME



KEEPER BUMPER
Inswing or Outswing
for Concealed Latch
1-1/4" Post
Part No. 9K1152 Chrom



KEEPER BUMPER
For Inswing
Flat Surface
Part No. 9A5990 Chrome
Part No. 9A5653 Cast SS

Strike and Keepers for Round Edge Posts

Fasteners Included, Chrome Plated Zamac Unless Indicated

TOILET PARTITION HARDWARE



KEEPER BUMPER
For Inswing 1-1/4" Post
Part No. 9G0151 - Chrome



KEEPER BUMPER
For Inswing 1-1/4" Post
Part No. 9A5330 - Chrome



KEEPER BUMPER
For Outswing 1-1/4" Post
Part No. 9G015E - Chrome



KEEPER BUMPER
For Outswing 1-1/4" Post
Part No. 9A5570 - Chrome
Part No. 9A5573 - Cast SS



KEEPER BUMPER
For Inswing 1-1/4" Post
Part No. 9A5580 - Chrome
Part No. 9A5583 - Cast SS



KEEPER BUMPER
For Inswing or Outswing 1-1/4" Post
7/16" w x 3/4" h slot.
Part No. 92060B - Chrome
Part No. 9A5513 - Cast SS



KEEPER BUMPER
For Inswing or Outswing 1-1/4" Post
1/4" w x 3/4" h slot.
Part No. 90C410 - Chrome



KEEPER BUMPER
For Inswing or Outswing
1-1/4" Rnd. Post
Part No. 9A5590

Common Toilet Partition Hardware

Aluminium Brackets



"U" BRACKET
1-1/2" high x 1-3/8" Long
PART NO. 9A1914 **THICKNESS** 1"



TWO-EAR BRACKET
3" high x 2-3/4" Long
PART NO. 9A2264 **THICKNESS** 1"



TWO-PEICE BRACKET
1-1/2" high x 2-1/2" Long
PART NO. 9A1864 **EARS** 1-1/2"



"U" BRACKET
3" high x 1-3/8" Long
PART NO. 9A2304 **THICKNESS** 1"



TWO-EAR BRACKET
1-1/2" high x 2-3/4" Long
PART NO. 9A1754 **THICKNESS** 1"



ONE-EAR BRACKET
1-1/2" high x 2-3/4" Long
PART NO. 9A1644 **THICKNESS** 3/4"
9A1764 1"
9A1844 1-1/4"



ONE-EAR BRACKET
3" high x 2-3/4" Long
PART NO. 9A2274 **THICKNESS** 1"
9A2294 1-1/4"

3" HIGH BRACKETS AVAILABLE — URINAL SCREEN BRACKETS 3-1/2" LONG AVAILABLE

Panel/Pilaster Brackets (Chrome Plated)



ALCOVE CLIP
1" Panel to
1-1/4" Pilaster
Part No. 9A0155



ALCOVE CLIP
For same thickness SS
2-5/8" X 1-1/2"
Part No. 9A8369



ALCOVE CHANNEL #4
BRUSHED ALUMINUM
1" Panel to
1-1/4" Pilaster
1-1/2" High
1-1/8" Wide
7/8" Round
53", 63" and 71" Lengths
Part No. 9A5601



ALCOVE CLIP SETS
(2 Per Set) Used to join Panel to
Pilaster edge to edge. 4 Sets of
Two required per Panel.
Part No. 9A8340



ANGLE BRACKETS
1-3/4" x 1-3/4"
Part No. 9A0160



TWO-EAR BRACKET
1-1/2" high x 2-1/2" Long
PANEL/PILASTER
PART NO. **THICKNESS**
9A0162 3/4"
9A0163 7/8"
9A0175 1"
9A0183 1-1/4"



ONE-EAR BRACKET
1-1/2" high x 2-1/2" Long
PANEL/PILASTER
PART NO. **THICKNESS**
9A0164 3/4"
9A0165 7/8"
9A0176 1"
9A0184 1-1/4"



"U" BRACKET
1-1/2" high x 1-3/8" Long
PANEL/PILASTER
PART NO. **THICKNESS**
9A0189 3/4"
9A0190 7/8"
9A0191 1"
9A0194 1-1/4"

Urinal Screen Brackets (Chrome Plated)



TWO-EAR BRACKET
1-1/2" high x 3 1/2" Long
PART NO. **THICKNESS**
9A1280 1"
9A1330 1-1/4"



SCREEN BRACKET
FOR ANY THICKNESS SCREEN
1-1/2" high x 3-1/2" long
Part No. 9A1320



SINGLE-EAR BRACKET
1-1/2" high x 3 1/2" Long
PART NO. **THICKNESS**
9A1270 1"
9A1310 1-1/4"



SCREEN BRACKET
PART NO. **THICKNESS** **LENGTH**
9AWB25 1 1/4" 6"
9AWB27 1" 12"

Pilaster Shoes 3" High (Stainless Steel)



ALUMINUM SQUARE POST ONLY
For 1-3/4" x 1-3/4" x 10"
Part No. 9A0303



FLOOR SHOE
For 1-3/4" x 1-3/4" Post
Part No. 9A0304



Split End
ROUND EDGE PILASTER SHOE
One End Split for Easy Installation.
1-1/4" x 2", 3", 4", 5", 6", 7",
8", 10", 12", 16", 18", 22" & 24"
Part No. 9A0308



Split End
SQUARE EDGE PILASTER SHOE
1-1/4" x 2", 3", 4", 5", 6", 7",
8", 9", 10", 11", 12" & 14",
16", 18", 20", 22", 24"
Part No. 9A0306

Headrail Brackets



END PLUG
For 1-1/2" x 1"
Rectangular Tubing
Part No. 9A0666



END PLUG
Overall Size 1" X 2"
Anti-grip Tubing
Part No. 9A0667



BRACKET
For 1-1/4" Thick Headrail
Part No. 9A0213
For 1" Thick Headrail
Part No. 9A0215

Partition Brace



"L" TYPE PARTITION BRACE - Stainless
Steel, Floor Mounted Unit supports 1/2" to
1-1/2" thick panels. Height is adjustable.
Part No. 9A6005 - Adjusts 11-1/2" to 14"
Part No. 9A85183 - Adjusts 9-1/2" to 12"
Part No. 9A85193 - Adjusts 7-1/2" to 10"

"U" TYPE PARTITION BRACE - Stainless
Steel, Floor Mounted Unit supports 1/2" to
1-1/4" thick panels. Height is adjustable.
Part No. 9A8503 - Adjusts 11-1/2" to 14"
Part No. 9A85083 - Adjusts 9-1/2" to 12"
Part No. 9A85093 - Adjusts 7-1/2" to 10"

NEXT DAY DELIVERY AVAILABLE

TOILET PARTITION HARDWARE